



Cintiq[®] 22HD

interactive pen display



User's manual

Cintiq 22HD (DTK-2200)

Setting up

Using the display stand

Using the pen

Customizing the pen

Using the pen display

Customizing the pen display

Using the Radial Menu

Application-specific settings

FAQs

Troubleshooting

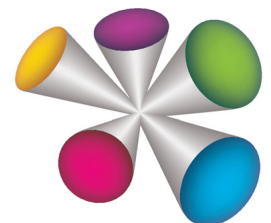



Cintiq 22HD

User's Manual

Version 1.0, Rev C0612

Copyright © Wacom Co., Ltd., 2012

All rights reserved. No part of this manual may be reproduced except for your express personal use.

Wacom reserves the right to revise this publication without obligation to provide notification of such changes.

Wacom does its best to provide current and accurate information in this manual. However, Wacom reserves the right to change any specifications and product configurations at its discretion, without prior notice and without obligation to include such changes in this manual.

The above year indicates when this manual was prepared. However, the date of release to the users of the "manual" is simultaneous with the introduction into the market of the applicable Wacom product.

Cintiq and Wacom are registered trademarks of Wacom Co., Ltd.

Adobe and Photoshop are either registered trademarks or trademarks of Adobe Systems Incorporated in the United States and/or other countries. Microsoft, Windows, and Vista are either registered trademarks or trademarks of Microsoft Corporation in the United States and/or other countries. Apple, the Apple logo, and Mac are trademarks of Apple, Inc., registered in the U.S. and other countries.

Any additional company and product names mentioned in this documentation may be trademarked and/or registered as trademarks. Mention of third-party products is for informational purposes only and constitutes neither an endorsement nor a recommendation. Wacom assumes no responsibility with regard to the performance or use of these products.

ExpressKey is a registered trademark of Ginsan Industries, Inc., and is used with permission.

Front cover image courtesy of www.daniellieske.com





TABLE OF CONTENTS

About the manual	5	Pen display controls	29
UNPACKING YOUR CINTIQ	6	Using the hardware control buttons	30
USING THE CINTIQ DISPLAY STAND	7	Using the ExpressKeys	31
Display stand features	8	Using the Touch Strips	33
Display stand location	9	Working with multiple monitors	35
Mounting Cintiq on the display stand	10	Adjusting the display	36
Adjusting the display incline	11	Factory presets, auto-sync, and user settings	36
Adjusting rotation	11	On Screen Display (OSD) settings	37
Removing Cintiq from the display stand	12	Power saving	39
SETTING UP YOUR CINTIQ	13	CUSTOMIZING YOUR CINTIQ	40
System requirements	13	Manage your control panel settings	41
Step 1: Hardware installation	14	Control panel overview	42
Step 2: Software installation	17	Calibrating the pen display	44
GETTING TO KNOW YOUR CINTIQ	18	Customizing the pen	45
Pen display features	18	Adjusting tip feel and double-click	46
Front view	19	Adjusting eraser feel	47
Rear view	20	Advanced tip and eraser pressure settings	47
Pen features	21	Customizing tool buttons	48
WORKING WITH YOUR CINTIQ	22	Customizing tilt sensitivity	49
Setting up your work area	22	Customizing pen display functions	49
Configuring Cintiq for handedness	24	Customizing the ExpressKeys	50
Using the Grip Pen	24	Customizing the Touch Strips	51
Holding the pen	25	Button functions	52
Positioning	26	Using and customizing the Radial Menu	59
Clicking	26	Working with Display Toggle	60
Dragging	27	Application-specific settings	61
Using the side switch	27	Creating an application-specific setting	62
Working with pressure sensitivity	27	Changing application-specific settings	63
Drawing with tilt	28	Removing application-specific settings	63
Erasing	28	Working with multiple tools	64
		Renaming the tablet in the tablet list	65





TROUBLESHOOTING	66	OTHER USEFUL INFORMATION	89
Testing Cintiq	67	Optional display configurations	90
Testing controls and input tools	69	Using an alternate mount or stand	91
Testing the hardware control buttons	70	Cable removal and replacement	94
Testing the ExpressKeys	70	Uninstalling Cintiq	96
Testing the Touch Strips	70	Using the Express View display	97
Testing a pen	71	Managing preferences	98
Display troubleshooting	72	Installing multiple tablets	99
General display problems	72	Using applications integrated for tablet control	100
VGA problems	74	Importing expert settings	101
Pen tablet troubleshooting	75	Pen and digital ink capabilities in Windows	102
General problems	75	Product information	103
Windows-specific problems	79	Ordering parts and accessories	104
Mac-specific problems	80	Available parts and accessories	104
Technical support options	82	GLOSSARY	105
Obtaining software updates	83	INDEX	108
FREQUENTLY ASKED QUESTIONS	84		
CARE AND MAINTENANCE	86		
Caring for Cintiq	86		
Replacing the pen nib	87		









ABOUT THE MANUAL

This manual provides quick access to information about your Cintiq. The information is common to Windows and Mac computers. Windows screen captures are shown unless otherwise noted.

- Go directly to [table of contents](#) or [index](#) topics by clicking on them.
- Use the navigation controls to move through the manual.

			Go to front page.
Contents	Go to table of contents.	 	Page back, or page forward.
Index	Go to index.		Go back to previous view.
topic	Go to topic.		Topic continued.

- Use your .pdf viewer zoom-in tool to increase the size of the manual on your display screen. See the viewer application help for information on any additional tools that help you use and print the manual.
- SMALL CAPITAL LETTERS are used to identify the names of keyboard keys, dialog boxes, and control panel options.
- Be sure to see also the Important Product Information guide for Cintiq, located on the Installation CD. The guide includes product safety precautions, specifications, and your license agreement.
- The following information is not included with this product: information about your specific computer hardware or operating system, or information about your application software. Your best source for this information is the set of manuals and discs that came with your hardware, operating system, or application.

Wacom's philosophy is to continually improve all of its products. As a result, engineering changes and improvements are made from time to time. Therefore, some changes, modifications, and improvements may not be covered in this manual.



UNPACKING YOUR CINTIQ

Your Cintiq 22HD interactive pen display comes with the Cintiq display stand and a variety of accessory parts. The product parts and accessories are packed together in the accessories box. To avoid damage, see the instructions on the following pages before setting up and using Cintiq or the Cintiq stand.

Carefully unpack and place all items on a stable surface. Save the packing materials and package box for use when shipping or storing Cintiq.

- Remove any packing materials from the back of the pen display and cabling.
- After unpacking, inventory and ensure the box contents are complete.

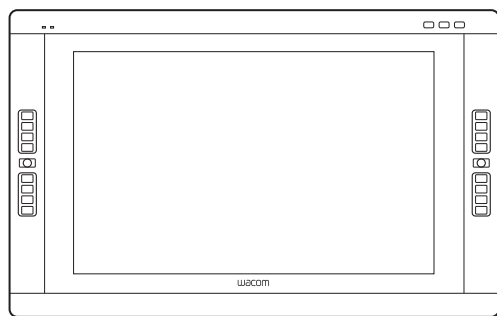

Cintiq interactive pen display



Rotation lock screws,
qty 2



Grip,
wide-bodied

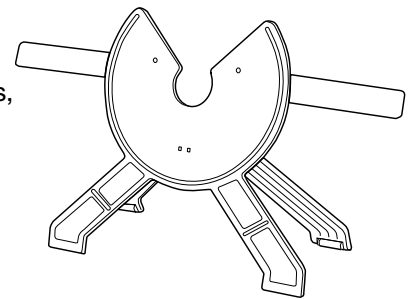

Patented Cintiq display stand
See [display stand features](#).

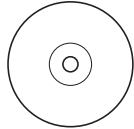

Installation CD

Includes the software driver and Important Product Information guide.

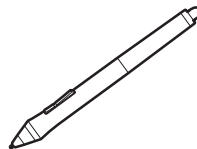

Pen, with personalization rings

To personalize, unscrew the tip cone and replace the ring with a different color.

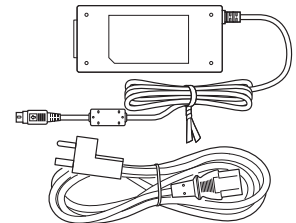

AC power adapter
and cable

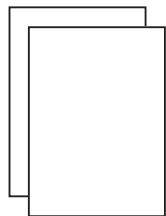

Quick Start Guide

Warranty card included with some configurations.

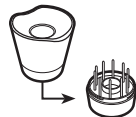

Pen stand,
includes replacement nibs
and nib extraction tool

Some configurations do not include all shown items. Check the product listing.

Note: Some configurations may include additional CDs or DVDs containing application software. To install, see the instructions for those CDs or DVDs.

Before installing, take some time to learn about your [Cintiq interactive pen display](#) and [Cintiq display stand](#).

USING THE CINTIQ DISPLAY STAND

The Cintiq display stand is designed to support the weight of your Cintiq interactive pen display.

- Cintiq can accommodate a variety of uses and working styles. Use the stand to adjust the working position of Cintiq so as to best meet your needs throughout the day.
- You can move or slide Cintiq to different locations on your desktop. Remember that you may need to adjust the incline to which you have positioned Cintiq before moving the pen display.



Adjust the display stand to a lower position as needed to emulate an easel, animator's table, or drafting table.

At the lowest position of the stand, Cintiq can be freely rotated to any angle without touching the desktop for the greatest comfort and accuracy of stroke while drawing or editing images.



Adjust the stand to a more vertical position when a large amount of keyboard input is required. This position is also useful when presenting your work to co-workers or clients.

[Display stand features](#)

[Display stand location](#)

[Mounting Cintiq on the display stand](#)

[Adjusting the display incline](#)

[Adjusting rotation](#)

[Removing Cintiq from the display stand](#)

DISPLAY STAND FEATURES

Place the Cintiq display stand on your desktop or other stable work surface. Select a level location where the stand is stable and will not tip or fall when the pen display is mounted on it. Take some time to familiarize yourself with the display stand components.

Incline adjustment levers

When Cintiq is mounted on the stand, use these levers to adjust the display incline. See [adjusting the display incline](#).

Bearing recess

Front feet

The front feet have rubber pads to reduce slippage on the desktop.

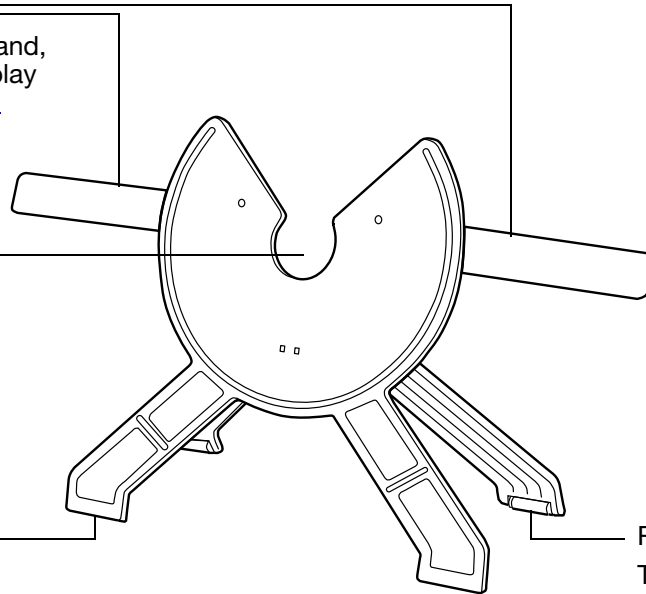

Rear feet

The rear feet are on rollers, allowing them to move when adjusting incline.

Warning

Do not operate the incline adjustment levers when Cintiq is not mounted on the stand, and do not lift the stand by the adjustment levers. The stand is spring-loaded and may cause injury or damage if released without the weight of Cintiq on the stand. Improper operation may lead to physical injury or damage to the stand. Be careful to avoid catching your finger in the gap of the movable portion of the stand.

Do not place on any unsteady surface or table. Do not place on slanted areas, unstable areas, or areas where vibration is present. Physical damage or personal injury may result if this product falls from an unsuitable surface.

Next: Mount the Cintiq interactive pen display on the Cintiq stand. See [mounting Cintiq on the display stand](#).



DISPLAY STAND LOCATION

Select a location on your desktop or other work surface that is level and stable.

- Choose a location on a desktop or other working surface that is flat, clean, and free of any moisture or oily film.
- Make sure the Cintiq display stand is placed in a stable position on your desktop or other work surface so that it will not tip or fall when Cintiq is mounted on it.

Warning

Place Cintiq securely on a level, stable desktop or other working surface.

Do not place this product on any unsteady surface or table. Do not place on slanted areas, unstable areas, or areas where vibration is present. Physical damage or personal injury may result if this product falls from an unsuitable surface.

Do not place this product on any wet surface or table. Doing so may cause the this product to slip, allowing the product to fall.



MOUNTING CINTIQ ON THE DISPLAY STAND

Before mounting Cintiq on the stand for the first time, remove any packing materials from the back of the pen display and cabling.

- Make sure the stand is placed in a stable position on your desktop or other work surface so that it will not tip or fall when Cintiq is mounted on it. Securely grasp Cintiq with both hands. The display should face toward you, with the power button on top and status LEDs located to the upper left.
- Align Cintiq parallel to the front of the display stand so the bearing hub is located between the V-shaped upper edges of the bearing recess. The V-shaped edges will serve as a guide for positioning the bearing hub. See – A – below.
- With the back of Cintiq resting against the stand, lower Cintiq until the bearing hub rests securely in the bearing recess. The pen display will be held in place by gravity. There will be no audible ‘snap’ to indicate a mechanical lock. See – B – below.

– A –

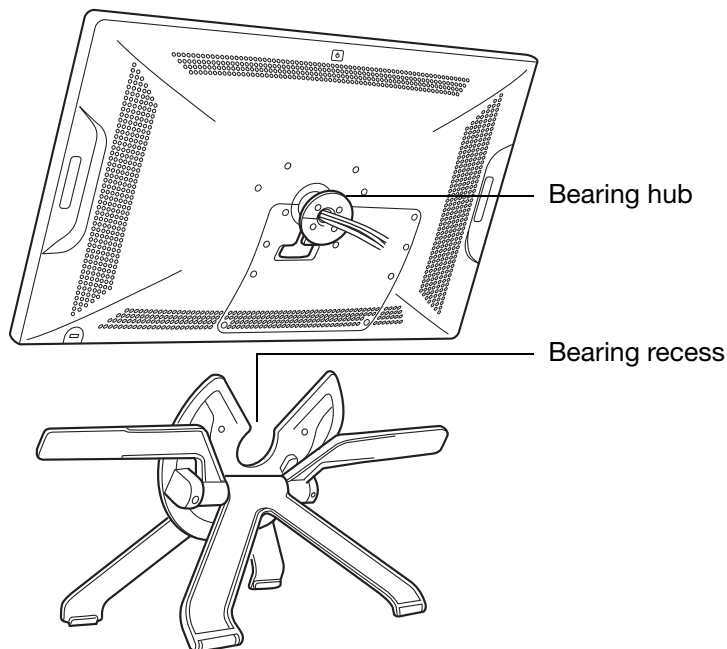

– B –

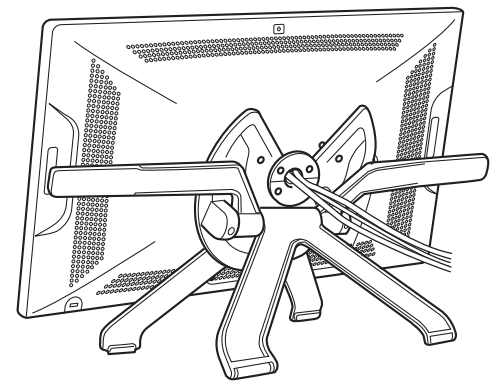

After mounting the pen display on the stand, remove the foam blocks that lock the adjustment levers in place. Save these blocks with the other packaging materials. You will need them if in the future you want to ship Cintiq.

Warning

When operating the incline adjustment levers, Cintiq must be mounted on the stand with the stand feet resting on a stable, flat surface. The stand is spring-loaded and can snap back quickly, causing injury or damage if not operated properly.

- Check for stability of the display stand. Carefully move the pen display and stand through their full range of motion. See [adjusting the display incline](#).
- If you do not need to rotate the Cintiq pen display, you can secure it to the stand with the rotation lock screws. See [optional display configurations](#).

To learn about other mounting options, see [using an alternate mount or stand](#).

ADJUSTING THE DISPLAY INCLINE

You can adjust the pen display height and incline to best meet your needs throughout the day.

To change the display incline or viewing angle, face the front of the pen display and grasp it on the left and right side at approximately the same height as the display stand adjustment levers. Use your fingertips to gently pull the incline adjustment levers toward the pen display. This will release a clutch mechanism. Tilt the display to adjust the incline setting.

- To lower Cintiq, pull the left incline adjustment lever toward Cintiq and gently lower Cintiq to the desired incline angle. Release the lever to lock the stand in place.
- To raise Cintiq, pull the right incline adjustment lever toward Cintiq and gently raise Cintiq to the desired incline angle. Release the lever to lock the stand in place.

Note: The incline adjustment levers exhibit some natural play before the clutch mechanism engages. When adjusting incline, set the display stand to an incline slightly higher than you plan to work with, then lower the display to the desired position.

Warning

Before moving Cintiq, first adjust the stand to its full upright position. This will reduce the spring tension so the stand will not accidentally release and snap shut. If the pen display is in landscape orientation, use one hand to grasp the bottom of the display and with your other hand grasp the back of the stand. Be sure to lift on both the display and the stand so the stand will not separate from the display when moving Cintiq.

If Cintiq is in portrait orientation or has been locked to the stand with the rotation lock screws, the stand will not separate from the pen display and Cintiq can be safely lifted by grasping the display with both hands. See [optional display configurations](#).

Next: Familiarize yourself with the pen display. See [getting to know your Cintiq](#).

ADJUSTING ROTATION

To adjust rotation, grasp Cintiq by the main body and rotate the pen display to the desired position. It will move on the bearing hub.

Cintiq can be rotated on the display stand when the incline is less than or equal to 25 degrees. You can only rotate the pen display 180 degrees in either direction.

If you do not plan to rotate the pen display, use the rotation lock screws and fasten the display to the stand in a horizontal position. See [optional display configurations](#).

REMOVING CINTIQ FROM THE DISPLAY STAND

The Cintiq interactive pen display has been specifically designed for use when mounted on the Cintiq display stand. However, there may be times when it will be necessary to remove the pen display from the stand. For example, you may want to locate the pen display on a suitable VESA mounting arm. See [using an alternate mount or stand](#).

To remove Cintiq from the display stand:

- If the rotation lock screws are attached, remove them from the back of Cintiq.
- Position the pen display to landscape orientation before removing it from the display stand. The stand will not release unless Cintiq is in landscape orientation.
- Next, raise the stand incline to the highest position. See [adjusting the display incline](#).
- Firmly grasp the pen display on both the left and right sides, and lift out of the display stand.

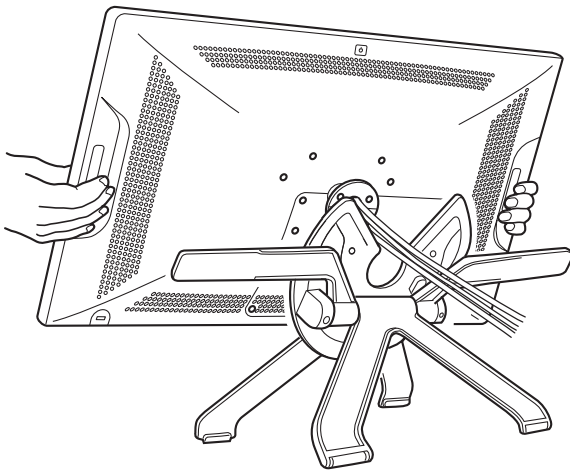

Important: When removing Cintiq from the display stand, always lift Cintiq in a direction parallel to the front of the stand. You may also need to slightly rotate Cintiq so the stand will release.

Note: When packing Cintiq for transport, first adjust the stand to its lowest position and place the foam packing blocks under the incline adjustment levers before removing Cintiq from the stand. The foam blocks will keep the stand from snapping shut while in its packaging. Always pack Cintiq and its stand in their original containers and protective cushions. Never pack Cintiq while it is mounted on the stand. Doing so may damage the pen display or stand during transport.



SETTING UP YOUR CINTIQ

Your Cintiq 22HD interactive pen display functions as both a display and a pen tablet. Follow the instructions below to complete the hardware and software installation.

Important: You **MUST** install the Wacom driver software for correct pen-on-screen functionality.

[System requirements](#)

[Step 1: Hardware installation](#)

[Step 2: Software installation](#)

SYSTEM REQUIREMENTS

Make sure your computer meets the following minimum system requirements:

- **PC.** Windows 7, Vista (SP2 or later), XP (SP3 or later). 32 or 64-bit configurations. DVI or VGA port. Available USB port and CD-ROM drive.
- **Mac.** OS X, v10.5.8 or later. Intel-based platforms only are supported. DVI or VGA port, or appropriate Mini DisplayPort to DVI adapter. Available USB port and CD-ROM drive.

Cintiq supports digital (DVI) and analog (VGA) video signals. For optimum performance, connect Cintiq to a digital video card.

VGA connection is not recommended as the display quality will not be as good as with a digital connection. VGA connection requires that you obtain an appropriate DVI-I to VGA adapter cable. Check with your local product retailer or an online outlet.

Notes:

Cintiq can be used alone or with another display, such as a CRT monitor or LCD projector. To use Cintiq with another display, you will need two video cards or a video card with dual output.

You may be able to set up Cintiq as a mirrored, extended, or independent display. When working with more than one monitor, Cintiq will map to the monitors based upon how your system is configured. By default, if you are in mirror mode, the pen display will map to the entire space on each monitor. See your hardware and operating system documentation for details on configuring your system for use with multiple monitors.

A [Display Toggle](#) function is available for use with multiple display systems. This enables you to toggle the screen cursor between Cintiq and your other displays.



STEP 1: HARDWARE INSTALLATION

In this step, connect the video, USB, and power cables.

If you have not already done so, [mount Cintiq on the display stand](#).

Important: Never connect or disconnect the video or power cables while your computer or pen display are powered on. This can damage the display or video card.

1. Turn off your computer.
2. Determine if your computer has a digital (DVI) or analog (VGA) port. If your computer has only one video port, unplug your previous monitor or add a second video card. For best results, connect Cintiq to a DVI-D or DVI-I card.
3. Follow the below instructions for your video port. Make sure to tighten any connector thumbscrews. See – A – in the [connection diagram](#).



DVI-I

For DVI operation, connect the Cintiq video cable to the DVI port located on your computer video card.

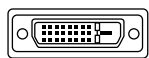

DVI-D

The Cintiq video cable has a DVI-D connector. Cintiq can be connected to either a DVI-D or a DVI-I card.

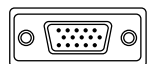

VGA

For VGA operation, you will need to obtain a Wacom accessory DVI-I to VGA adapter cable. See [ordering parts and accessories](#).

Remove the DVI-D cable from Cintiq and replace it with a DVI-I to VGA adapter cable. See [cable removal and replacement](#). Connect the adapter cable between the Cintiq and your video card.

If connecting to a Mac Mini DisplayPort, you will need to obtain an appropriate active adapter cable, such as those offered by Kanex, Apple, or other manufacturers. Check with your local product retailer or an online outlet for availability.

Connect the adapter between the DVI-D end of the Cintiq video cable and your Mac.

4. Plug the USB connector into an available USB port on your computer or USB hub attached to your computer. See – B – in the [connection diagram](#).
5. Connect the power adapter to Cintiq. See – C – in the [connection diagram](#).
6. Connect the adapter power cable and plug into an AC outlet. See – D – in the [connection diagram](#).
7. Turn on the pen display. The power LED will glow orange.



Cintiq cabling diagram

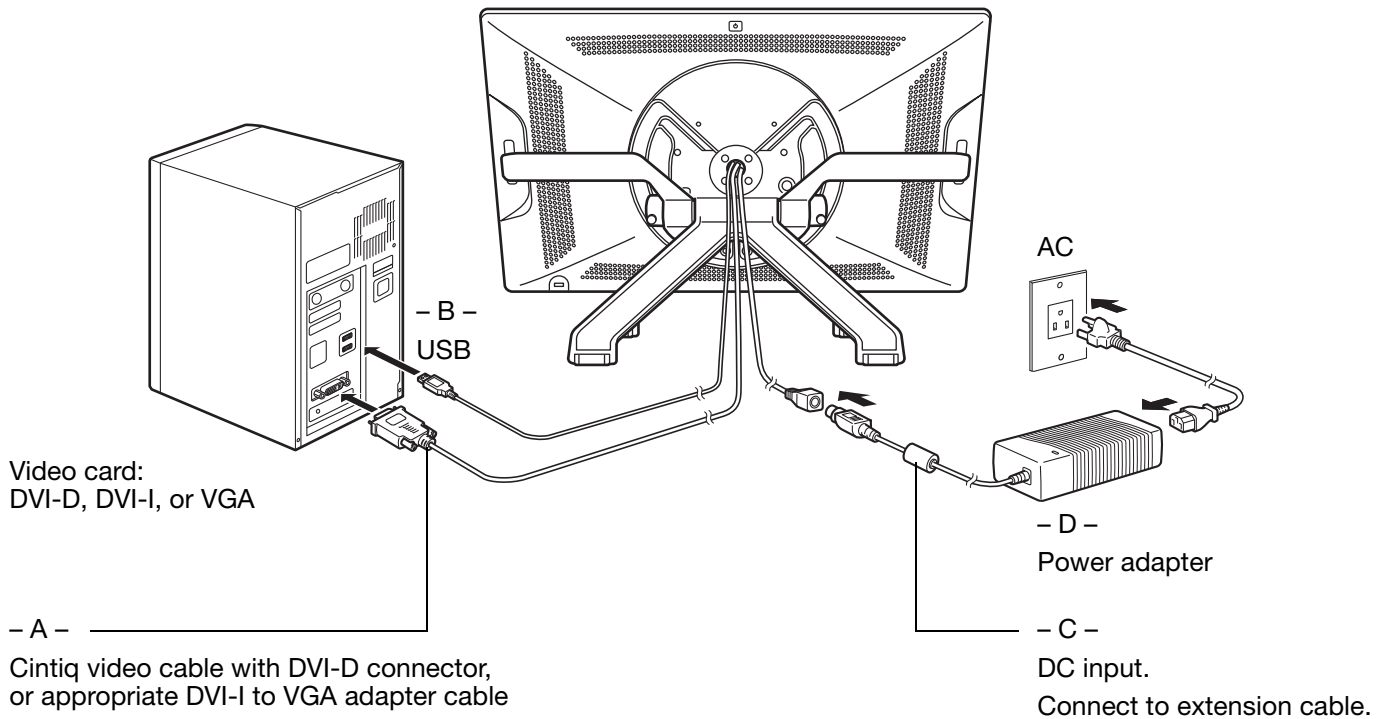

Caution

Do not connect or disconnect the video or power cables while Cintiq or your computer are turned on. This can damage the display or computer video card.

Only use a power adapter specified for use with your pen display. Use of an improper power adapter may damage the pen display.



8. Turn on your computer. The interactive pen display will install as a default monitor.
9. As necessary, configure the display control panel settings for the proper size and color resolution. For best results, set Cintiq to the maximum (native) resolution of 1920x1080. See the Important Product Information guide located on the Installation CD for details about resolution sizes that can be used with Cintiq. The display size and color resolution may be constrained by the capabilities of your video card. To fine-tune, see [adjusting the display](#).

Windows: If you are using Cintiq as a secondary display, you may first need to enable Cintiq in your display properties control panel.

After the LCD monitor portion of the installation is working to your satisfaction, move on to [step 2: software installation](#).

Notes:

Each LCD panel is produced under very stringent quality standards. Production techniques cannot guarantee an absolutely perfect display. Wacom does not allow any pixel to be always white or always black. A small number of pixels are allowed to show a wrong color for some parts of the color spectrum. See the Important Product Information guide for more information.

If an image has fine striping (such as screen stripes), it may appear to flicker or display a moiré pattern.

Do not apply excessive pressure on the display screen surface, it may cause the appearance of a moiré or pooling pattern. If this occurs, use less pressure on the display screen when working with the pen.

When a still image is displayed for a long period of time, an after-image may remain for a short time. To prevent this, use a screen saver or other power management feature.

To extend the life of the pen display backlight, set your computer's power management to turn off the display when not in use for extended periods of time.

Your eyes may feel more comfortable if you reduce the display screen brightness when working with Cintiq for extended periods of time. This will also extend the life of the backlight and reduce the heat felt on the display screen surface.

Some models may include a color profile on the Installation CD. To activate for use with Cintiq, first identify Cintiq as a pen display in the system display settings control panel. Then select the Cintiq profile in the color management control panel. For details, see the color management information in your operating system and application documentation.

For troubleshooting tips, see [troubleshooting](#).

STEP 2: SOFTWARE INSTALLATION

Important: You **MUST** install the Wacom driver software for correct pen-on-screen functionality.

Save your work and close all open applications. Temporarily disable any virus protection programs.

1. Insert the Installation CD into your computer's CD-ROM drive. If the software installer menu does not display, double-click on the INSTALL icon located on the CD. (When available, you can also download and install the latest software driver from the Wacom web site for your region.)
2. Click INSTALL TABLET and follow the prompts to install the driver software.
3. Reactivate your virus protection program.
4. After completing the software installation, make sure you can use your pen on the Cintiq display screen to move the screen cursor.

When you place the pen tip on the display screen, the screen cursor should immediately jump to a corresponding position approximately beneath the pen tip. Lift the pen tip and place it on the display screen surface in a different location. The screen cursor should again jump to the new position. This is known as absolute positioning, and enables you to position the screen cursor without having to drag your pen across the display screen surface.

5. Check the Read Me file for updated information. Review also the Important Product Information guide located on the Installation CD for cautions and warnings. If you have trouble installing Cintiq, see [troubleshooting](#).
6. Next, precisely align the screen cursor with the pen tip position. See [calibrating the pen display](#).

Notes:

User-specific preferences are supported. After logging on, each user can customize their personal settings in the Wacom Tablet control panel. Switching to another user (either by logging on or fast user switching methods) will load the settings for that user.

If the pen display does not respond properly or you lose cursor control, the pen display preferences may be corrupted. See [managing preferences](#) to delete the current preference settings and return the pen display to its factory default condition.

Driver installation automatically activates the pen input functions available within Microsoft Windows 7, Vista, and Office 2007 or later (except for Windows 7 Starter and Home Basic, and Windows Vista Home Basic). See [pen and digital ink capabilities in Windows](#).

To download a new software driver (when available) from the Internet, see [obtaining software updates](#).

To uninstall the software driver, see [uninstalling Cintiq](#).

GETTING TO KNOW YOUR CINTIQ

The Cintiq 22HD interactive pen display combines the benefits of a Liquid Crystal Display (LCD) with the control, comfort, and productivity of Wacom's cordless, battery-free pen technology. This gives you a direct pen-on-screen interface for your computer.

The basic components of your Cintiq include a Wacom pen tablet internally mounted behind a high quality color display, the Wacom Grip Pen, and the [Cintiq display stand](#).

This manual describes how to [set up](#) and [use](#) your Cintiq. The Wacom Tablet control panel enables you to customize your pen and pen display settings. To learn more, see [customizing](#).

Note: Not all product models are available in all regions.

[Pen display features](#)

[Pen features](#)

PEN DISPLAY FEATURES

After the Cintiq pen display is safely mounted on the Cintiq stand, take some time to familiarize yourself with the features and components of your Cintiq interactive pen display. Although they will appear as separate devices to your operating system, the display and tablet sensor function as an integrated output and input device. The tablet sensor reports pen coordinates, pressure, tilt, switch, eraser, and other information.

- Many applications have built-in support for pen display features (such as pressure sensitivity, tilt, and rotation). Visit the Wacom web site to learn about applications that support these features. See [product information](#).
- For information on how best to use pen display features within a specific application, see the instructions in that application's manuals.

[Front view](#)

[Rear view](#)

FRONT VIEW

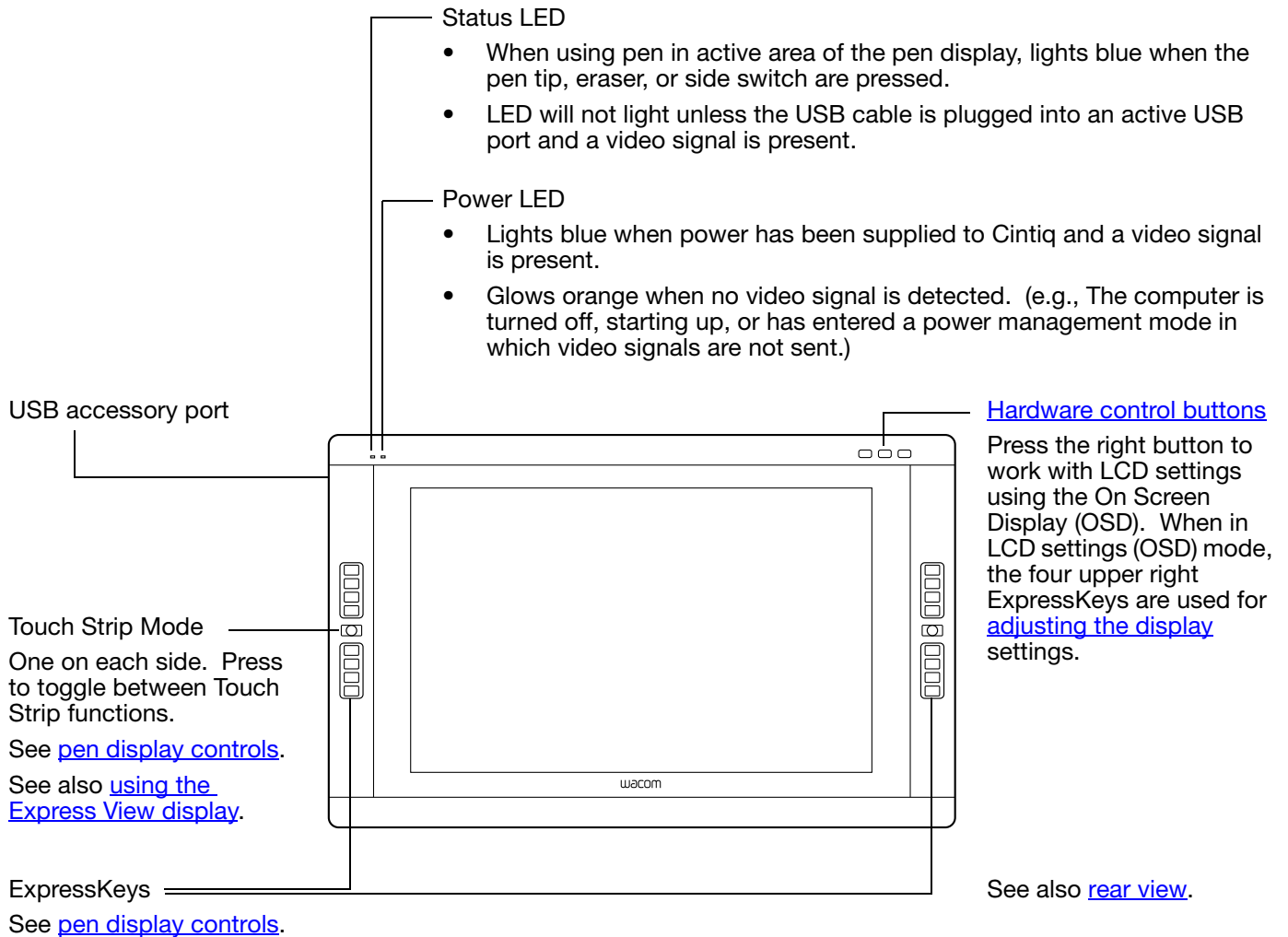

REAR VIEW

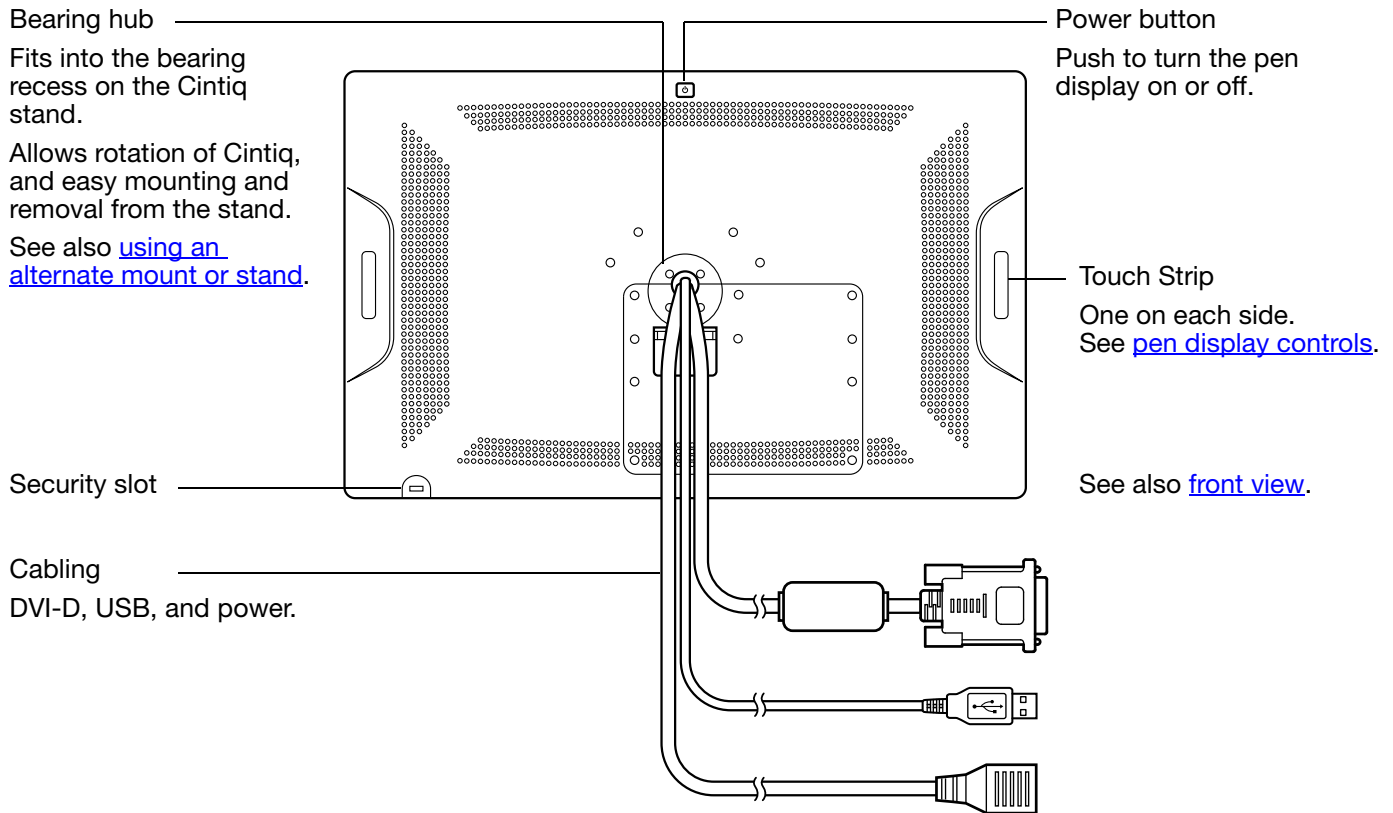

Important: Always store the interactive pen display on the Cintiq display stand or in its original packing carton when not in use. Do not store the pen display on a surface that would excessively bend or crimp the cables.

Next step: Review the [pen features](#) and learn about the [Cintiq display stand](#). Then, if you have not already done so, move on to [setting up your Cintiq](#).

PEN FEATURES

Eraser: When brought within proximity of the pen display screen, the tablet portion of the display reports the pen location. Pressure information is reported as you press down on the eraser. By default, the function is set to ERASE.

Side switch: Be sure the customizable side switch is in a convenient location where you can toggle it with your thumb or forefinger but not accidentally press it while using the pen.

You can use the switch whenever the pen tip is within proximity of the display screen. You do not need to touch the pen tip to the display surface.

Toggle the switch in either direction to activate the button functions. By default, the upper switch is set to DOUBLE CLICK and the lower switch is set to RIGHT CLICK.

Pen tip (replaceable nib): The pen activates as soon as it is brought within proximity of the pen display screen. This allows you to position the screen cursor without touching the pen tip to the display screen.

When pressure is applied to the pen tip, the pen simulates a primary mouse button click. Tip click pressure can be adjusted in the Wacom Tablet control panel.

Tips:

- The pen enters proximity when the tip or eraser is brought within 5 mm (0.2 inch) of the pen display screen surface.
- To resume operations after the pen display has entered auto sleep mode, bring the pen tip within proximity or touch the pen tip on the pen display screen.

Important:

- Use only the pen that came with your product, or a Wacom accessory pen specified for use with Cintiq. Other pens may not function properly. See [available parts and accessories](#). Also, the Cintiq pen tip is specifically designed for use with the Cintiq pen display. The tips on other pens could damage the Cintiq display screen.
- When not in use, place the pen in the pen stand or lay it flat on your desk. To maintain the sensitivity of your pen, do not store it in a container where it will rest on the tip or eraser. Improper storage may damage pen tip pressure sensor(s).

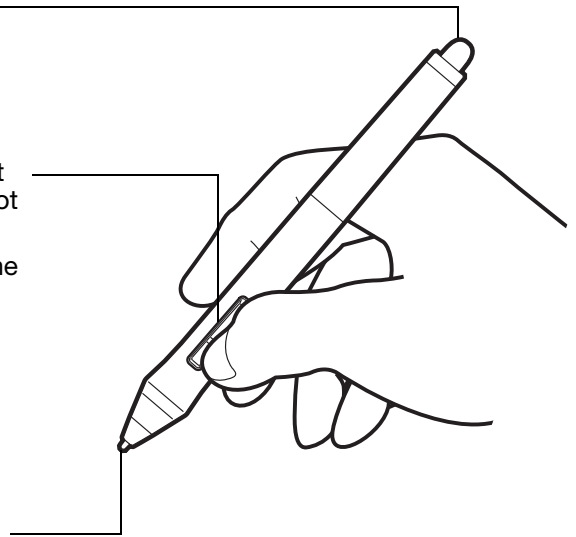

WORKING WITH YOUR CINTIQ

The Cintiq 22HD interactive pen display and Cintiq display stand were designed for a wide range of flexibility and ergonomic work approach. The design allows you to quickly adjust Cintiq to a different height and position whenever the need arises. Experiment by [adjusting the display incline](#) to determine which best fits your particular working style and tasks.

As you work with Cintiq you can rest your hand lightly on the display screen, just as if it were a drawing board or sheet of paper.

Because the Cintiq pen display surface will be a little higher than your desk, consider adjusting the height of your desk or chair to assure comfortable use of the device.

[Setting up your work area](#)

[Configuring Cintiq for handedness](#)

[Using the Grip Pen](#)

[Pen display controls](#)

[Working with multiple monitors](#)

[Adjusting the display](#)

SETTING UP YOUR WORK AREA

To minimize fatigue, organize your work area to create a comfortable environment. Position Cintiq, the pen, and your keyboard for easy access without unnecessary reaching. The pen display and any other displays should be positioned so you can view them comfortably with a minimum of eyestrain.

- If you have not already done so, be sure to [configure Cintiq](#) for your preferred handedness.
- When using Cintiq as a display, align the top of the pen display in line with the level of your eyes.



[Adjust Cintiq](#) to a position that best meets your creative needs.

- If working with a keyboard, consider locating the keyboard slightly below the desk surface in an adjustable keyboard tray.
- Maintain a good posture at all times.





- Periodically shift your gaze from your computer and focus on other objects within the room. This will help to relax your eyes.
- Use a gentle grip when working with the pen. Take short breaks between tasks to stretch and relax your muscles.
- Alternate tasks throughout the day. Minimize awkward postures and repetitive movements.
- Change your position if you feel any discomfort.
- Alternate between different modes of use. For example, every few hours adjust the Cintiq display stand to a different working position.
- Study the rest of this chapter to learn more about working with Cintiq.
- Learn about the basics of [customizing](#) Cintiq for the way you like to work.

Tips:

- Do not pull the cabling from their computer connections by accidentally moving the pen display too far from the computer.
- If the rotation lock screws are attached to the back of Cintiq, they must be removed before Cintiq can be rotated.
- Before rotating the pen display, be sure the cables are freely rotating behind the unit.
- Cintiq can also be mounted to articulated arms or other third-party stands meeting the VESA MIS-D 100/100 (4 screw) specification for monitor stands. See [using an alternate mount or stand](#) for details.

Note regarding RSI: Wacom makes no representation, promise or guarantee that Wacom products will cure or prevent, in whole or in part, mouse-induced repetitive stress symptoms, injuries or conditions. Individual results may vary. Always obtain competent medical advice to determine the most appropriate treatment for your specific situation.



CONFIGURING CINTIQ FOR HANDEDNESS

During the installation process, you were prompted to choose a default configuration for Cintiq based on whether you are right- or left-handed. The configuration you chose was used to determine the default settings for the ExpressKeys and Touch Strips.

However, you can use the Wacom Tablet control panel to easily reconfigure Cintiq for left- or right-handed users at any time. The ExpressKey and Touch Strip settings are automatically reconfigured when you change the handedness setting.

To reconfigure for left- or right-handed users:

1. Launch the Wacom Tablet control panel by pressing the center [hardware control button](#). Click **OPTIONS...**
2. Choose the appropriate setting for your preferred handedness.
3. Click **OK**. The existing ExpressKey and Touch Strip settings are swapped (or flipped) between left and right.

Notes:

The hardware control buttons are not affected when you change the handedness setting.

Likewise, changing the handedness setting does not affect the ExpressKeys used to control the LCD settings when in LCD settings (OSD) mode.

This procedure does not affect the default orientation. At the system log on and user switching screens, the pen display uses the default configuration you chose during the install process. To change the default configuration, you must re-install the Wacom driver.

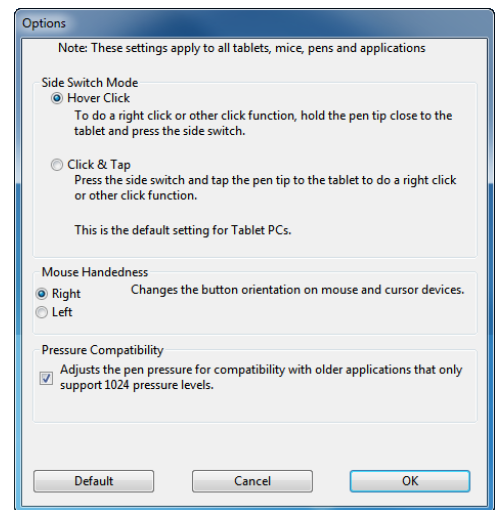

USING THE GRIP PEN

The cordless, battery-free pen senses the amount of pressure and tilt you apply to the tip. There are four basic techniques for using the pen: pointing, clicking, double-clicking, and dragging. If you are unfamiliar with using the pen, see the following pages.

[Holding the pen](#)

[Positioning](#)

[Clicking](#)

[Dragging](#)

[Using the side switch](#)

[Working with pressure sensitivity](#)

[Drawing with tilt](#)

[Erasing](#)

HOLDING THE PEN

Hold the pen like you would a normal pen or pencil. Adjust your grip so that the side switch is in a convenient location where you can toggle it with your thumb or forefinger. Be careful not to accidentally press the switch while drawing or positioning with the pen. Tilt the pen in any way that feels most comfortable. As you work with Cintiq you can rest your hand lightly on the display screen.

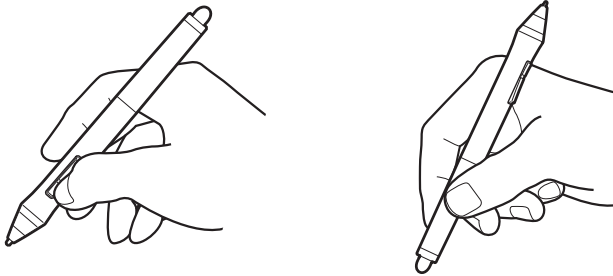

If you are working in a multi-user environment or otherwise want to personalize your pen, unscrew the tip cone and replace the colored ring with one of another color (included).

You can [customize](#) the pen settings at any time.

Place the pen stand within easy reach. When not in use, place the pen in the pen stand or lay it flat on your desk. The stand allows for vertical or horizontal placement of the pen.

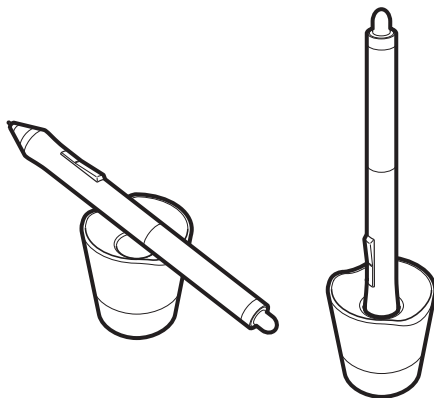

Unscrew the base of the pen stand to access a nib removal tool and assorted replacement nibs.

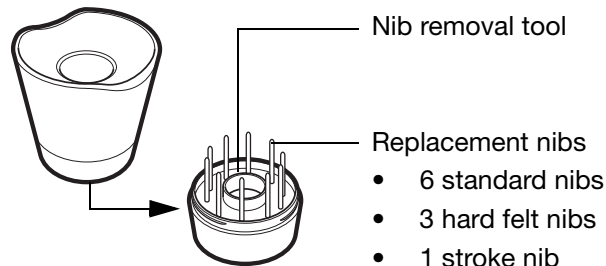

- 6 standard nibs
- 3 hard felt nibs
- 1 stroke nib

Important: To maintain the sensitivity of your pen, do not store it in a container where it will rest on the tip or eraser. Improper storage may damage the pen tip pressure sensor(s).

POSITIONING

To position the screen cursor, move the pen slightly above the Cintiq display screen without touching the screen surface. Press the pen tip on the display screen to make a selection.

Note: [Calibrating the pen display](#) ensures correct alignment of the screen cursor with the pen tip. If the screen cursor does not jump to a position near the pen tip when you place the pen on the display screen, then the pen display software driver may not be installed or is not loading. Install the driver software if necessary. Otherwise, see [troubleshooting](#).

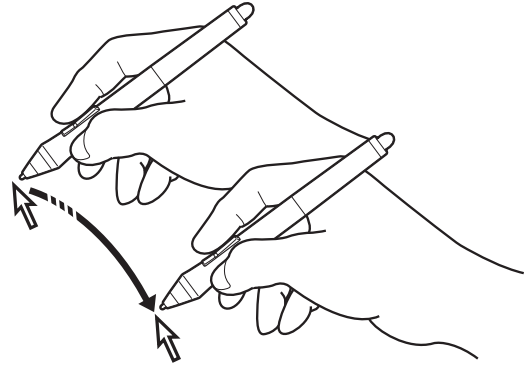

CLICKING

Tap the display screen once with the pen tip, or touch the pen to the display screen with enough pressure to register a click.

Tip: Configure Windows to select when hovering the pen over an icon and to launch the icon with a single click. To turn on this feature, first open a folder.

Windows 7 and Vista: From the ORGANIZE pull-down menu choose FOLDER AND SEARCH OPTIONS. From the GENERAL tab select SINGLE-CLICK TO OPEN AN ITEM (POINT TO SELECT).

Windows XP: From the TOOLS pull-down menu choose FOLDER OPTIONS.... From the GENERAL tab select SINGLE-CLICK TO OPEN AN ITEM (POINT TO SELECT).

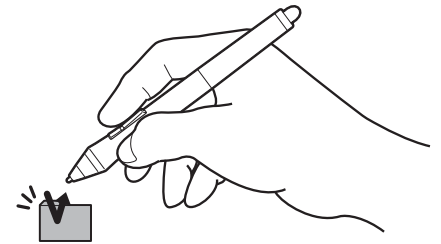

Press the upper side switch (when set to DOUBLE CLICK), or quickly tap the display screen twice in the same place with the pen tip. Double-clicking is easier when using the pen perpendicular to the pen display screen.

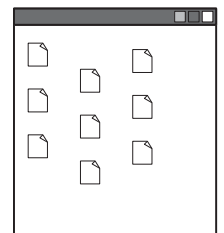
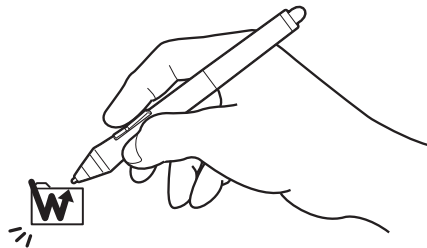

DRAGGING

Select an object, then slide the pen tip across the display screen to move the object.

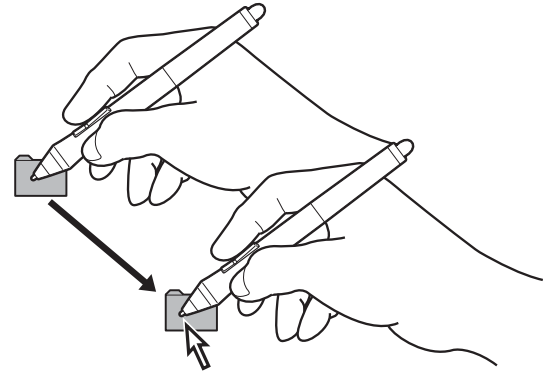

USING THE SIDE SWITCH

The pen comes equipped with a side switch. This switch has two customizable functions that can be selected by rocking the switch in either direction. You can use the side switch whenever the pen tip is within proximity (5 mm (0.2 inch)) of the display screen surface. You do not need to touch the pen tip to the display surface in order to use the switch. By default, the upper switch is set to DOUBLE CLICK, and the lower switch is set to RIGHT CLICK. You can [customize](#) or disable the switch functions using the Wacom Tablet control panel.

WORKING WITH PRESSURE SENSITIVITY

The pen responds to the nuance and inflection of your hand movements, enabling you to create natural-looking pen and brush strokes within applications that support this feature.

To draw, ink, or write with pressure sensitivity, move the pen along the display screen surface while applying various amounts of pressure downward on the tip of the pen. Press hard for thick lines or dense color. Press gently for thin lines or softer color. Some applications require that you first select a pressure-sensitive tool from the application tool palette.

To adjust tip feel, see [adjusting tip feel and double-click](#).

Visit the Wacom web site to learn about applications that support pressure. See [product information](#).

DRAWING WITH TILT

The pen display recognizes when you tilt the pen from vertical to incline positions. Tilt can be used to control line shape and thickness in supporting applications.

Visit the Wacom web site to learn about applications that support tilt. See [product information](#).

ERASING

In supporting applications the pen eraser works like the eraser on a pencil. In text applications, use the eraser to select text and then lift the eraser from the pen display screen to delete the text.

Visit the Wacom web site to learn about applications that support the eraser. See [product information](#). If the eraser is not supported in an application, you can still use the eraser for positioning, drawing, or annotation.

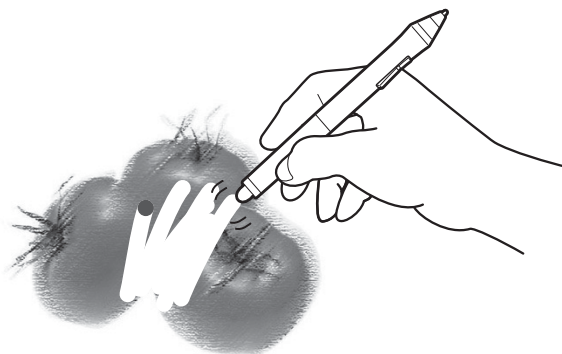

PEN DISPLAY CONTROLS

To improve your workflow in graphics or other applications, Cintiq features ExpressKeys and Touch Strips. While using the pen with your dominant hand, you can simultaneously use your other hand to operate the ExpressKeys or Touch Strip.

Touch Strips

Located on back of pen display, one on each side.

Slide your finger over the Touch Strip to zoom, scroll, or issue assigned keystroke actions. See [using the Touch Strips](#).

Hardware control buttons

Press a button to activate the assigned function. See [using the hardware control buttons](#).

Touch Strip Mode

Press to toggle between Touch Strip functions. The left button toggles the left Touch Strip functions, and the right button toggles the right Touch Strip.

Each time you press a Touch Strip Mode button, an overlay appears briefly on your display screen to show the function assignments.

See also [using the Express View display](#).

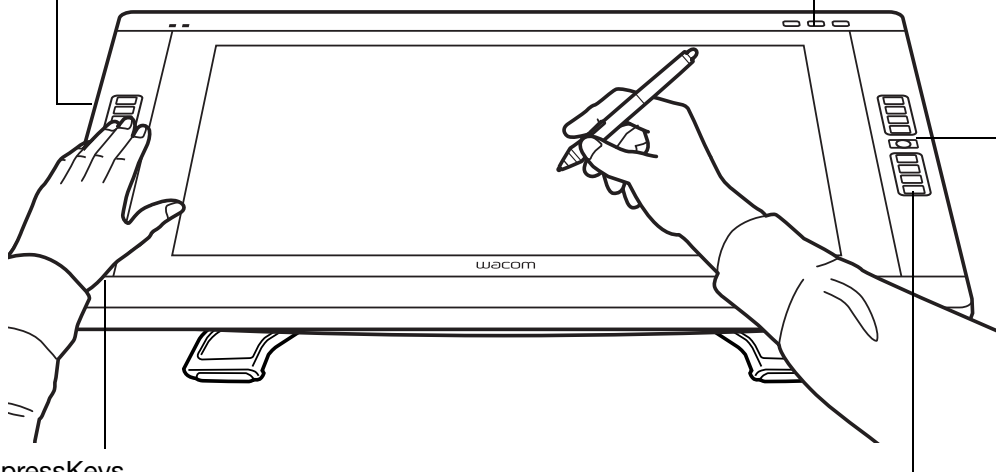

ExpressKeys

Press the customizable keys to perform frequently used functions or keystrokes, or to emulate button clicks or modifier keys. See [using the ExpressKeys](#).

A [Display Toggle](#) function is available for use on multiple monitor systems. This feature enables you to toggle the screen cursor between Cintiq and your other displays. For example: Cintiq can be used as a pen display where the cursor is positioned at the pen tip location, or toggled for use as a standard Wacom tablet where the cursor can be moved across the entire desktop or any display on your system.

USING THE HARDWARE CONTROL BUTTONS

Press a button to:

- Display a diagram of your current Cintiq settings.
- Launch the Wacom Tablet control panel.
- Work with LCD settings using the On Screen Display (OSD).

Press the button again to toggle off the function.

Toggles the four upper right ExpressKeys between normal operation and the LCD settings ([On Screen Display](#)) mode.

In LCD settings (OSD) mode, the OSD menu is activated on your display screen and the upper right ExpressKeys are used for [adjusting the display](#). Press to toggle back to ExpressKeys mode.

Launches the Wacom Tablet control panel.

Press to close the control panel when open.

Shows (on your display screen) a diagram of the pen display ExpressKey, Touch Strip, and pen settings.

The current functions for each control are shown. Press to dismiss the diagram.

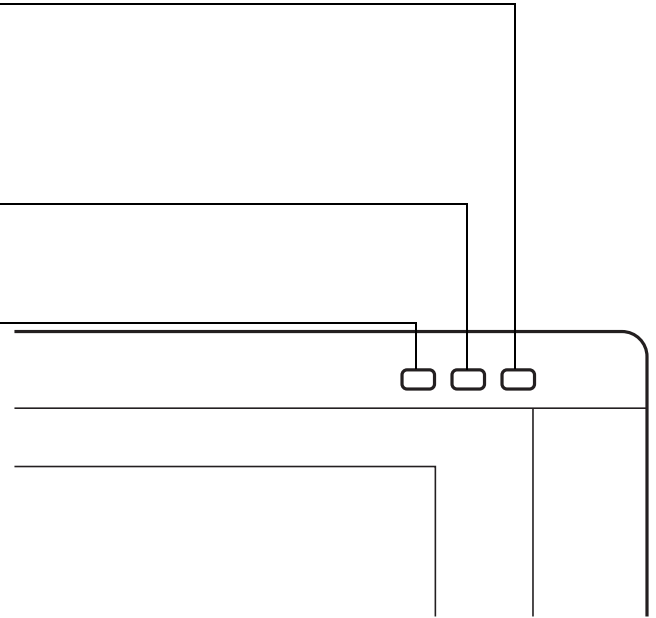

Notes:

- You may notice a slight delay in response time, depending on the speed of your computer.
- The control buttons cannot be customized.

USING THE EXPRESSKEYS

Press individual keys to perform frequently used functions or keystrokes. ExpressKeys can also be used to modify your pen or other input tool properties as you work.

Default settings are listed below. Right-handed configuration shown. For left-handed configuration, the ExpressKey settings are swapped (or flipped) between left and right.

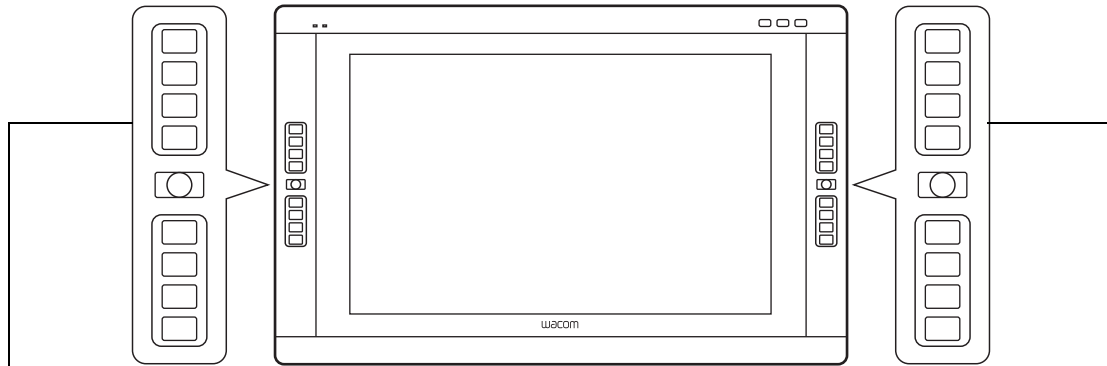

UNDO

[RADIAL MENU](#)[PRECISION MODE](#)[DISPLAY TOGGLE](#)

SHIFT

CTRL/COMMAND

ALT/OPT

[PAN/SCROLL](#)

REDO

SAVE

TAB

NEW LAYER

BRUSH PANEL

ON SCREEN KEYBOARD

FIT ON SCREEN

COPY MERGED

Note: The ExpressKeys can be operated in combination with one another. For example, program one key for the CTRL function and another for ALT. When you press both keys at the same time a CTRL+ALT function is initiated.



Tips:

- Use the [Radial Menu](#) to expand the functionality of your Cintiq.
- Press a Touch Strip Mode button for 2 seconds or more to activate the [Express View display](#), which shows the ExpressKey settings.
- Display an interactive diagram of the current pen display settings by pressing the appropriate [hardware control button](#) at the top of the pen display. You can also press an ExpressKey or other tool button set to [SETTINGS](#).

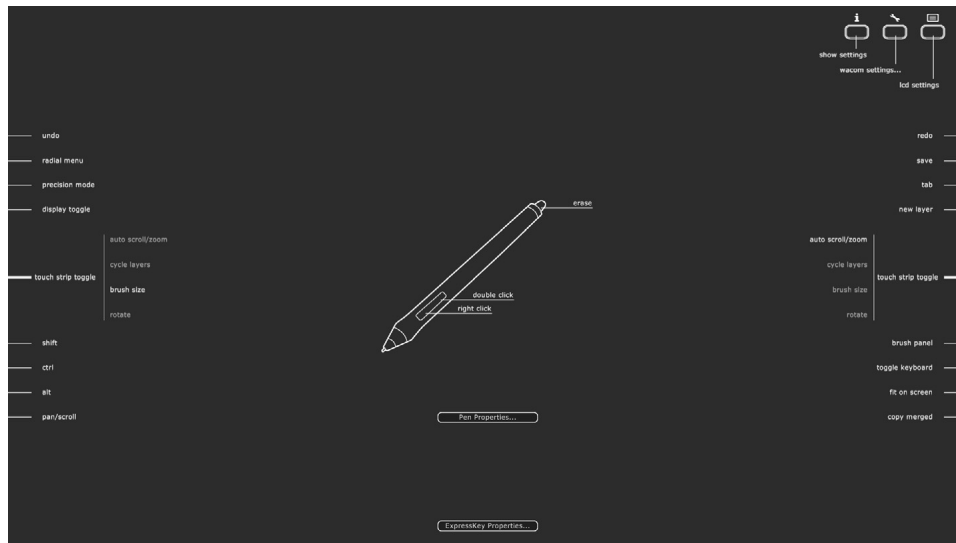

Consider some of these ways to use the ExpressKeys:

- Set a key to a commonly used keyboard shortcut.
- Set a key to launch a commonly used file or application.
- If you prefer not to (or cannot) use the side switches on your Grip Pen, then set a key to right- or double-click.
- Choose from any of the other available [functions](#). See [customizing the ExpressKeys](#) for details.

Important: Some applications can override and control the ExpressKey functions. For details, see [using applications integrated for tablet control](#).

Use the Wacom Tablet control panel to customize the ExpressKey options.

[Manage your control panel settings](#)

[Control panel overview](#)

[Customizing the ExpressKeys](#)

USING THE TOUCH STRIPS

Slide your finger over the Touch Strip to zoom in or out, scroll down or up, or issue an assigned keystroke function.

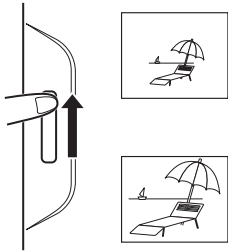

Example of zooming out

Move your finger upward to zoom out or scroll up. Tap the upper portion of the Touch Strip for single increment changes.



Example of zooming in

Move your finger downward along the strip to zoom in or scroll down in most applications. Tap the lower portion of the Touch Strip for single increment changes based on the assigned function.

Press a Touch Strip Mode button (located on front of pen display) to toggle between customizable states. The left button toggles the left Touch Strip functions, and the right button toggles the right Touch Strip. Any disabled settings are skipped in the toggle sequence.

As you press each button, an overlay appears briefly on your display screen to show the button assignments.

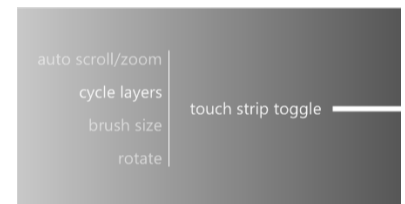

Tap upper or lower portion of strip for incremental changes.
Press and hold your finger at either end of strip to continuously scroll.

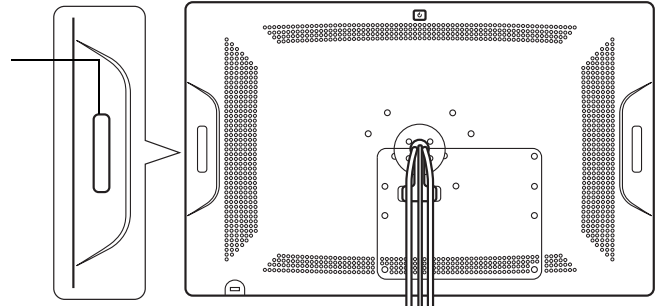

Default settings are the same for both Touch Strips.

AUTO SCROLL/ZOOM. Sets the strip to zoom in graphics applications and scroll in other applications. Some applications may interpret zooming as scrolling, or may completely ignore zooming. Similarly, scrolling may be interpreted as zooming, or ignored completely.
--

CYCLE LAYERS. Sets the strip to cycle layers in applications that support this function.
--

BRUSH SIZE. Sets the strip to increase or decrease the brush size of your drawing tool when working in Adobe Photoshop.

ROTATE. Enables you to rotate or flip an entire image when working in Adobe Photoshop CS4 or later.

Note: In some regions the defaults may vary, depending on application and operating system differences. See [customizing the Touch Strips](#) to modify how the Touch Strips work.

For left-handed configuration, the Touch Strip settings are swapped (or flipped) between left and right.

Important: Some applications can override and control the Touch Strip functions. For details, see [using applications integrated for tablet control](#).

Use the Wacom Tablet control panel to customize the Touch Strip options.

[Manage your control panel settings](#)

[Control panel overview](#)

[Customizing the Touch Strips](#)

WORKING WITH MULTIPLE MONITORS

When working with Cintiq and additional monitors on the same system, the screen cursor movement on the standard monitors will depend on your system configuration.

If a second monitor is connected in mirror mode, both Cintiq and the other monitor will show identical images and screen cursor movement.

If you are using Cintiq with other monitors in extended monitor mode, you have several options for navigating on the other monitors:

- Set an ExpressKey or pen side switch to the DISPLAY TOGGLE function. You can then press the button to toggle the screen cursor between Cintiq and your other displays.

For example: Cintiq can be used as a pen display where the screen cursor is positioned at the pen tip location on the pen display screen surface. [Display Toggle](#) enables you to use Cintiq as a standard Wacom tablet where the screen cursor can be moved across the entire desktop or additional displays.

- Set a pen side switch or an ExpressKey to MODE TOGGLE. You can then quickly switch between pen mode for working on Cintiq and mouse mode for working on the other monitors.

You can also purchase an Intuos5 tablet and use it to work on the other monitors in PEN mode. The pen will work on both Cintiq and the tablet.

ADJUSTING THE DISPLAY

Use the Cintiq controls to adjust a variety of display settings.

[Factory presets, auto-sync, and user settings](#)

[On Screen Display \(OSD\) settings](#)

[Power saving](#)

FACTORY PRESETS, AUTO-SYNC, AND USER SETTINGS

Factory presets: For optimal display quality, set your video card to a resolution of 1920x1080. This is the maximum (native) resolution that can be used with Cintiq. See the Important Product Information guide for details.

Auto-sync: Cintiq automatically synchronizes to the incoming signal. The auto-sync function sets the horizontal and vertical screen position, as well as pitch and phase. Auto-sync will function between the supported horizontal and vertical frequency ranges. See the Important Product Information guide for details.

If Cintiq does not synchronize with the incoming signal, you can use the OSD RESET or AUTO ADJUST options to initiate display synchronization. Further screen display adjustments can be manually made using the On Screen Display (OSD) settings.

Color calibration: Changing the color, color temperature, contrast, brightness, or backlight from their default settings will override the color profile used with Cintiq.



ON SCREEN DISPLAY (OSD) SETTINGS

The OSD function enables you to optimize a variety of pen display settings at the touch of a button.

- Press the LCD settings button to toggle the four upper right ExpressKeys to LCD settings (OSD) mode. The OSD menu will appear on your display screen. See [using the hardware control buttons](#).
- When in LCD settings (OSD) mode, the upper right ExpressKeys are used to adjust the display settings. Follow the on-screen prompts as you work with the OSD.

Use the ExpressKeys to navigate and adjust the available menu options shown in the OSD.

- Select the highlighted item. _____
- Navigate up, or increase selected value. _____
- Navigate down, or decrease selected value. _____
- Return to previous menu level. _____

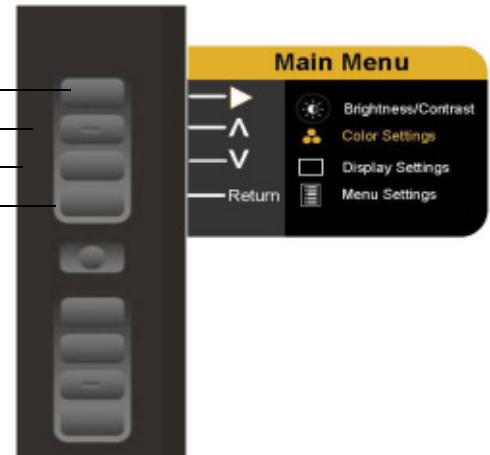

Notes:

Press the OSD toggle button to close the menu. All settings are saved when the OSD menu closes and will be used the next time the pen display receives a similar video signal. This is applicable to all display modes.

If you make changes to the display appearance and cannot return to the original settings, use the RESET option to return the pen display to its original factory defaults.





Menu options are available when you open the On Screen Display.

BRIGHTNESS/CONTRAST options include:

- BRIGHTNESS. Increases or decreases the image brightness.
- CONTRAST. Increases or decreases image contrast. Changes in contrast may affect color accuracy.
- BACKLIGHT. Increases or decreases the backlight brightness level.

CUSTOM RGB options include:

- RED. Independently adjusts the red color value.
- GREEN. Independently adjusts the green color value.
- BLUE. Independently adjusts the blue color value.

Any changes you manually make to the color settings will override the color profile settings.

COLOR PRESETS include:

- 5000K, 6500K, 9300K. Enables you to adjust the pen display color temperature, in degrees Kelvin. Default is 6500K.
- DIRECT displays the colors directly from the video card without any adjustment. When selected, contrast or brightness cannot be adjusted.

DISPLAY SETTINGS include:

- SCALING options.

FULL. Resizes the image to fill the whole screen.

ASPECT. Resizes the image to fill as much of the screen as possible while maintaining the correct aspect ratio.

1:1. Displays the image at the actual resolution.

- HORIZONTAL POSITION. (VGA only.) Changes the horizontal position of the image. To automatically adjust, use the AUTO ADJUST option.
- VERTICAL POSITION. (VGA only.) Changes the vertical position of the image. To automatically adjust, use the AUTO ADJUST option.





VGA SETTINGS include:

- **PHASE.** (VGA only.) Synchronizes the signal timing of the pen display to that of your graphics card. Use when you experience an unstable or flickering image, or horizontal distortion lines.
- **PITCH.** (VGA only.) Changes the display data frequency to match that of your graphics card. Use when you experience an unstable or flickering image, or vertical distortion lines.
- **AUTO ADJUST.** (VGA only.) Choose this function to automatically optimize the display screen image.

OTHER SETTINGS include:

- **LANGUAGE.** Choose the language in which to display the OSD menu.
- **MENU TRANSPARENCY.** Changes the opaqueness of the OSD menu background.
- **RESET** returns the display parameters of the current mode to their factory default settings.

POWER SAVING

Cintiq conforms to VESA power saving guidelines.

When used with a Display Power Management Signaling (DPMS) compliant computer or video card, the display will automatically comply with the power saving parameters shown below.

COMPUTER MODE	H-SYNC	V-SYNC	VIDEO	POWER LED
Power ON	Yes	Yes	Active	Blue
Standby mode	No	Yes	Blanked	Orange
Suspend mode	Yes	No	Blanked	Orange
OFF mode	No	No	Blanked	Off

When power-saving functions are in effect, the screen display is darker than usual.





CUSTOMIZING YOUR CINTIQ

After mastering the basics of using your pen and Cintiq 22HD interactive pen display, you may want to customize the way Cintiq works. This chapter describes how to adjust your pen display and input tool settings.

Advanced users can learn how to further optimize Cintiq by creating [application-specific settings](#).

[Manage your control panel settings](#)

[Control panel overview](#)

[Calibrating the pen display](#)

[Customizing the pen](#)

[Customizing pen display functions](#)

[Button functions](#)

[Using and customizing the Radial Menu](#)

[Working with Display Toggle](#)

[Application-specific settings](#)

[Working with multiple tools](#)

[Renaming the tablet in the tablet list](#)



MANAGE YOUR CONTROL PANEL SETTINGS

Launch the Wacom Tablet control panel by pressing the appropriate Cintiq [hardware control button](#).

You can also open the Wacom Tablet control panel using the pen on the pen display:

- **Windows.** Click on the Windows START button and choose ALL PROGRAMS. Then select WACOM TABLET and choose the WACOM TABLET PROPERTIES option.
- **Mac.** Open SYSTEM PREFERENCES from either the Dock, the Apple menu, or from the APPLICATIONS folder. Then click on the WACOM TABLET icon.

You can begin customizing Cintiq after opening the control panel. See [control panel overview](#).

Note: User-specific preferences are supported. After logging on, each user can customize their personal settings in the Wacom Tablet control panel. Switching to another user will load the settings for that user.

Tip: Display an interactive diagram of the current pen display settings by pressing the appropriate [hardware control button](#) at the top of the pen display.

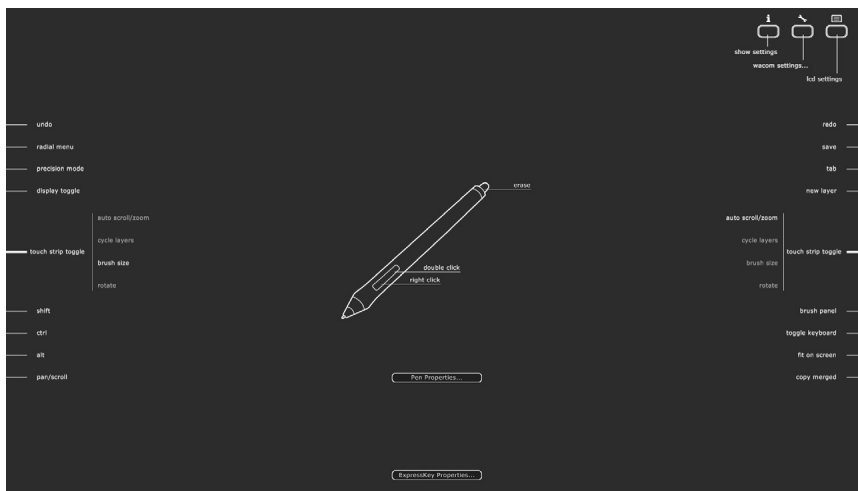

Click on any section of the diagram to open the appropriate Wacom Tablet control panel tab.

Settings may vary depending on your product model.

CONTROL PANEL OVERVIEW

Use the Wacom Tablet control panel to customize your Cintiq or Grip Pen. When you open the control panel, an icon for the Grip Pen or other input tool is displayed in the TOOL list. The appropriate tabs are displayed.

To customize, make changes to the tab controls. Experiment with different settings to find what works best for you. Any changes you make will take effect immediately. Click DEFAULT to return to the factory settings.

Icons represent your pen display (TABLET), TOOL, and APPLICATION settings.

Choose FUNCTIONS to customize the ExpressKey, Touch Strip, and [Radial Menu](#) settings. [Display Toggle](#) options are available on multiple monitor systems.

Choose GRIP PEN to customize the pen settings. The icon is available after you have used a pen on the pen display.

Tabs display customizable settings for the selected TOOL.

Displays information dialog, and option to **DIAGNOSE...** your product.

Displays [advanced options](#).

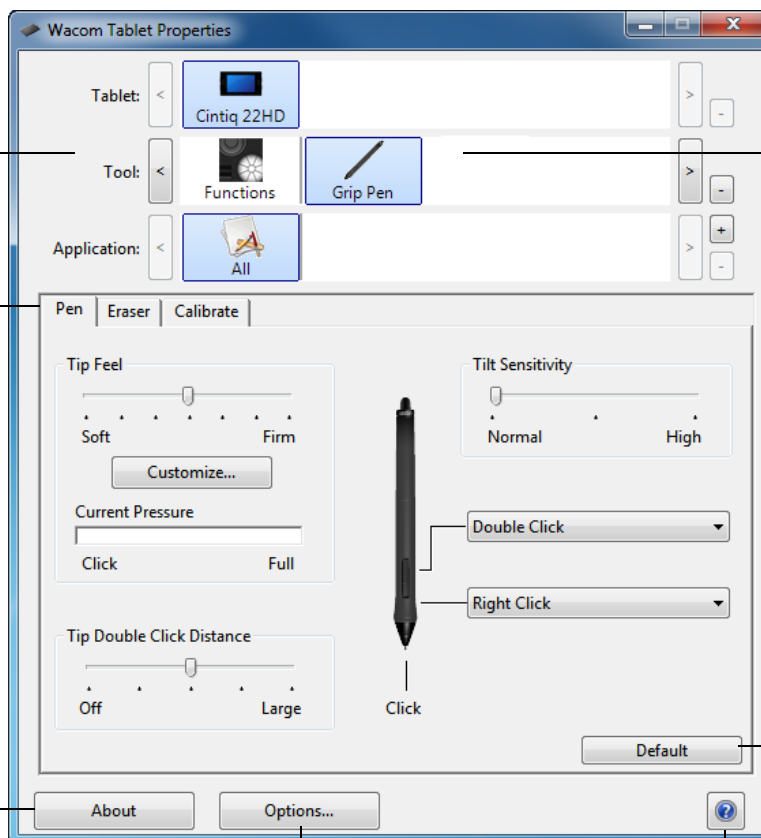

Resets the selected tab to its default settings.

Downloads or displays this manual.

Tool Tips are available for most control panel items. Position the screen cursor over an item and let it rest there. The appropriate Tool Tip will pop up in a few moments.

Your keyboard tab and arrow keys can also be used to navigate the control panel.



Control panel lists and tabs: The control panel TABLET, TOOL, and APPLICATION lists allow you to select the pen display or tablet, tool, or application for which you want to change settings.

The TABLET list displays an icon for any supported pen display or tablet that has been installed on your system and is currently connected. All settings shown below the list apply to the selected pen display or tablet.

- The control panel will not launch unless a supported pen display or tablet is connected to the computer.
- Settings can only be viewed or changed for an attached pen display or tablet.
- A pen display or tablet cannot be deleted from the control panel list unless it is attached to the computer.

See also [installing multiple tablets](#) and [renaming the tablet in the tablet list](#).

The TOOL list displays icons for the pen display FUNCTIONS and for the different tools that have been used on the pen display.

To customize settings for a tool, click on its icon within the TOOL list. The appropriate tabs will be displayed. See [customizing pen display functions](#) and [customizing the pen](#).

Note: The pen will be automatically added to the TOOL list when first used on the pen display, and functions using the default settings.

See also [working with multiple tools](#).

Use the APPLICATION list to define TOOL settings that apply only to a specific application. See [application-specific settings](#).

Note: The APPLICATION list is optional. It is not necessary to select or add applications in order to customize your Cintiq tool(s).

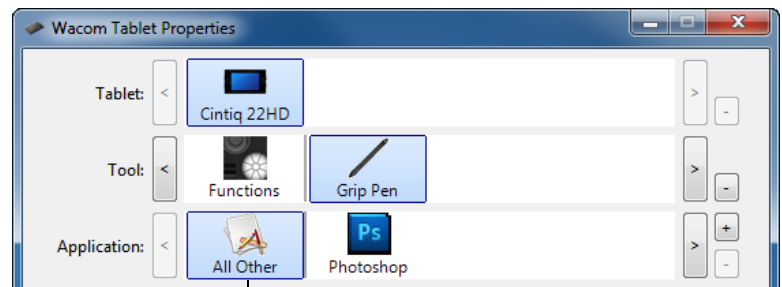

Current selections are highlighted.

CALIBRATING THE PEN DISPLAY

For optimum performance, you must calibrate the pen display to align the screen cursor with the position of the pen on the display screen. This is required to compensate for viewing angle, and to adjust for [parallax](#). Set Cintiq in its working position, then follow the below procedure.

Important: If using a VGA connection, first **RESET** the pen display. See [On Screen Display \(OSD\) settings](#).

1. Open the Wacom Tablet control panel.
If more than one pen display is installed on your system, select the pen display you are working with from the TABLET list.
2. Select GRIP PEN from the TOOL list.
Then select the CALIBRATE tab.
3. If you are working with multiple monitors, select the MONITOR corresponding to your Cintiq. Only monitors that are set to one of the resolutions supported by Cintiq will appear in the list.
4. Click CALIBRATE... to activate the calibration screen.
5. Hold the pen and position your head as you normally do when working with the pen display. Use the pen tip to click on the center of the crosshairs in the upper-left corner.
6. Then click on the center of the crosshairs that are displayed in the upper-right, lower left, and lower right corners.
7. Test the alignment by positioning the pen at a few different points on the display. Click OK to accept the calibration. Click TRY AGAIN to recalibrate.

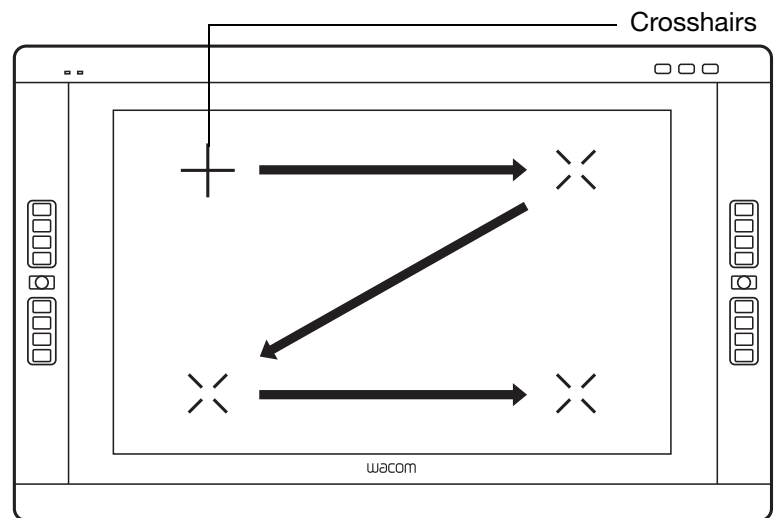

Tip: To see the screen cursor slightly offset from the actual position of the pen tip, calibrate by clicking on a spot showing that offset from the crosshairs. For example, to have the screen cursor appear 2.5 mm (1/10th of an inch) above and to the left of the pen tip, calibrate by clicking on a spot 2.5 mm (1/10th of an inch) below and to the right of the crosshairs.

CUSTOMIZING THE PEN

Use the pen when opening the Wacom Tablet control panel. The pen will be selected in the TOOL list and the appropriate tabs will be displayed. If not selected, choose the pen from the TOOL list. Select a tab and choose from the available options.

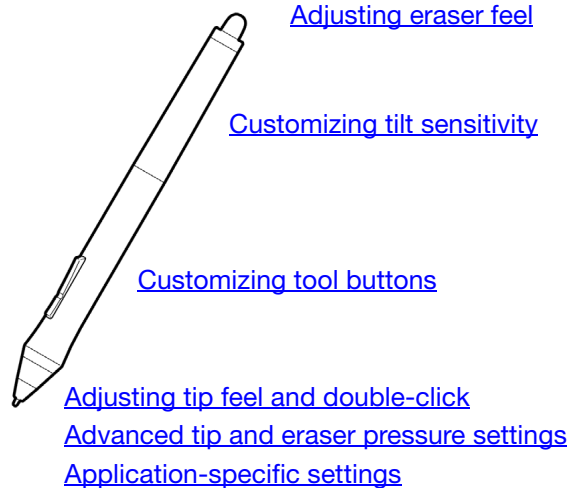

Wacom offers a number of optional pens, such as the Art Pen and Airbrush, that are compatible for use with Cintiq.

- The Art Pen features a pressure-sensitive tip and eraser, as well as sensitivity to tilt and rotation. Rotating the barrel in supporting applications creates a unique effect.
- The Airbrush is a true digital airbrush. It features a pressure-sensitive tip and eraser, tilt sensitivity, and a fingerwheel to control the application of digital paint.

These tools are fully supported in the Wacom driver software. They will appear in the TOOL list of the Wacom Tablet control panel after you touch the pen display screen with the tip of the tool. The control panel will update to show the new tool and the options available for customization.

In supporting applications you can adjust the functionality of the Art Pen rotation or the Airbrush fingerwheel within the application. See the documentation that came with your application for details.

To learn more about these and other optional tools that can be used with Cintiq, visit the Wacom web site for your region. On the web site you can also learn about applications that currently support the advanced features of these tools.

ADJUSTING TIP FEEL AND DOUBLE-CLICK

To adjust the tip sensitivity of your pen, select the PEN tab.

Customizes the amount of pressure needed to click, draw, or ink.

To create broad brush strokes or to click with a light touch, use a SOFT tip setting. For maximum control while drawing thin lines, use a FIRM tip setting.

Click to [further customize](#) the tip sensitivity.

With your screen cursor positioned over an empty area of the control panel, press down on the pen display screen with your pen tip. Use the pressure bar to determine how hard you must press on the pen to reach maximum pressure.

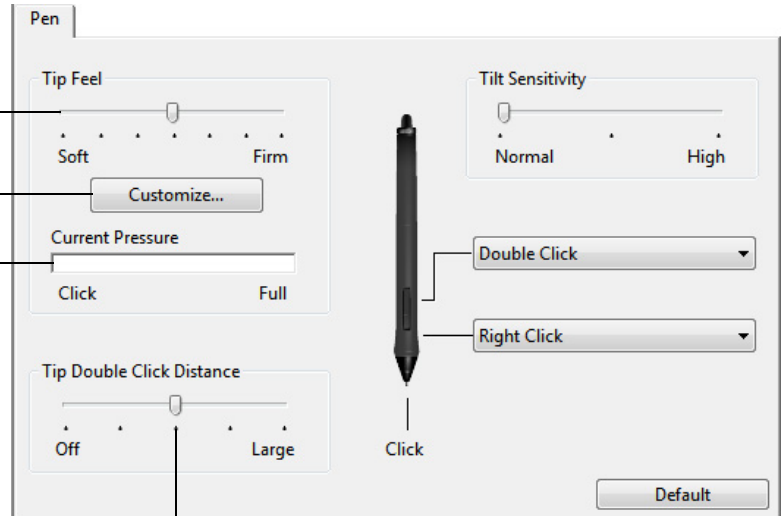

Adjusts the size of the double-click area. Drag slider to OFF if you do not want [double-click assist](#).

Tips:

- Use a soft TIP FEEL for a wider range of pressure values in most pressure-sensitive applications.
- In some applications a soft pressure setting can make the pen overreact so that slight pressure on the pen will be magnified on the screen. If you experience this, try a firmer TIP FEEL setting.
- To make double-clicking easier, expand the tap area that accepts a double-click (the double-click distance).
- A large double-click distance may cause a delay at the beginning of brush strokes in some drawing applications. This may also cause a delay at the beginning of a drag action or inking stroke. If you notice such effects, try setting a smaller double-click distance and using the side switch to double-click. You can also [set an ExpressKey to double-click](#).

ADJUSTING ERASER FEEL

To adjust the eraser sensitivity of your pen, select the ERASER tab.

Customizes the amount of pressure needed to erase.

Click to [further customize](#) the eraser sensitivity.

With your screen cursor positioned over an empty area of the control panel, press down on the pen display screen with your pen eraser. Use the pressure bar to determine how hard you must press on the eraser to reach maximum pressure.

Select the [function](#) to perform when using the eraser.

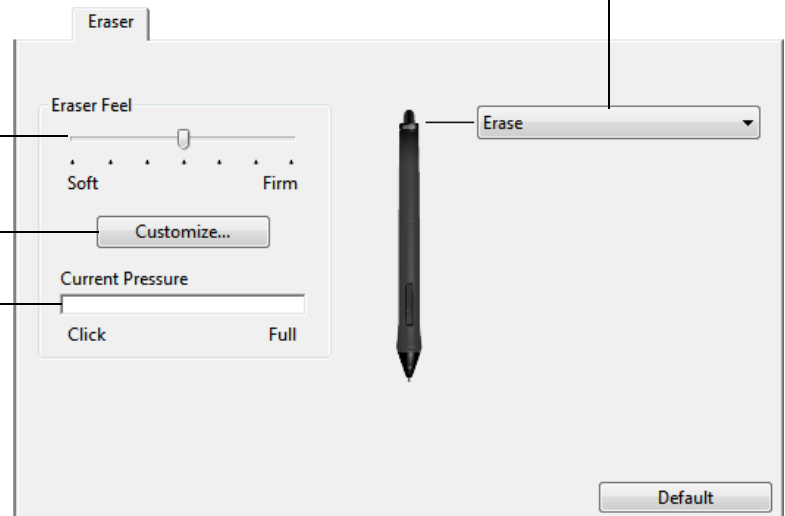

ADVANCED TIP AND ERASER PRESSURE SETTINGS

To further customize tip or eraser pressure settings, select the PEN or ERASER tab and click on the CUSTOMIZE... button. Options within the PEN FEEL DETAILS dialog box enable you to independently change the tip or eraser pressure sensitivity and click threshold settings.

Graphically displays the selected pressure sensitivity curve and click threshold settings.

Move the pressure controls to change the sensitivity curve.

- **CLICK THRESHOLD** determines the amount of force required to register pressure or generate a tip click.
- Use the **SENSITIVITY** control to change the slope of the pressure response curve.
- **MAX PRESSURE** determines how hard you must press the pen tip to reach maximum pressure.

A curve that increases quickly makes the pen feel more sensitive.

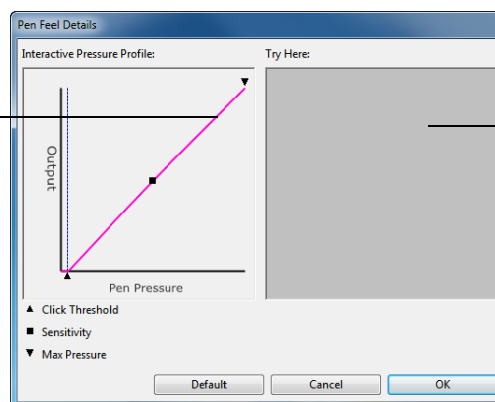

Using your pen tip or eraser, make several strokes within the box to test the results of your changes.

Important: In the PEN and ERASER tabs, these settings are adjusted simultaneously with the TIP FEEL or ERASER FEEL slider, which override the advanced pressure settings.

CUSTOMIZING TOOL BUTTONS

Select the PEN tab to change the functions assigned to the side switches and tip of your pen.

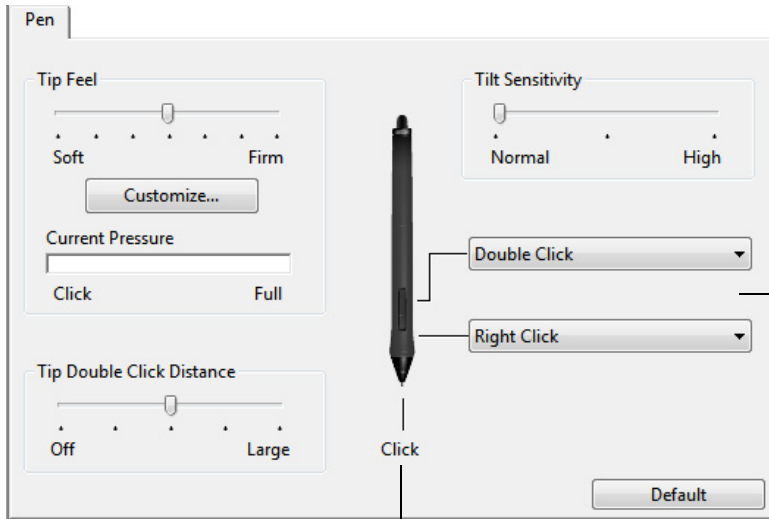

Select the [function](#) to perform when pressing the upper or lower side switch.

The selected function occurs when you bring the pen tip within 5 mm (0.20 inch) of the display screen surface without touching the screen and then press the upper or lower side switch.

Tip: To make double-clicking easier, set the side switch to DOUBLE CLICK.

Double-click here to change the pen tip function.

- At least one tool button should be set to the CLICK function.
- The tip must be set to CLICK in order to draw in most graphics applications.

You can change the SIDE SWITCH MODE to best fit the way you like to use the pen when making right-clicks or other click functions. Click on the control panel OPTIONS... button.

Select:

- HOVER CLICK to perform click functions without touching the pen tip to the display screen surface. This is the default setting for all except Tablet PCs.
- CLICK & TAP to enable the precise placement of click functions. When selected, you must first press the side switch then touch the pen tip to the display screen surface in order perform the function.

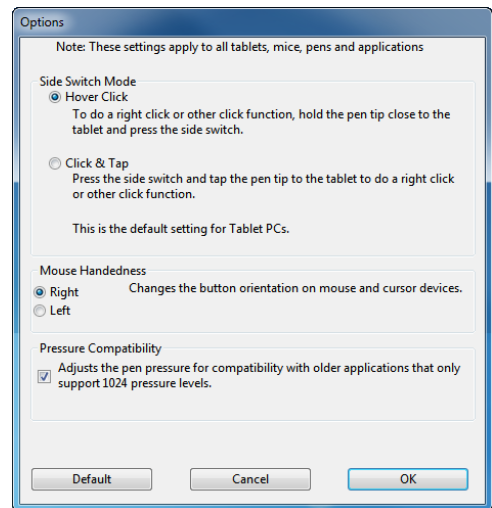

CUSTOMIZING TILT SENSITIVITY

To adjust the tilt sensitivity of your pen, select the PEN tab. Tilt sensitivity determines how far you have to tilt the tool to produce the maximum tilt effect. You need to tilt the pen less at high sensitivity than at low sensitivity.

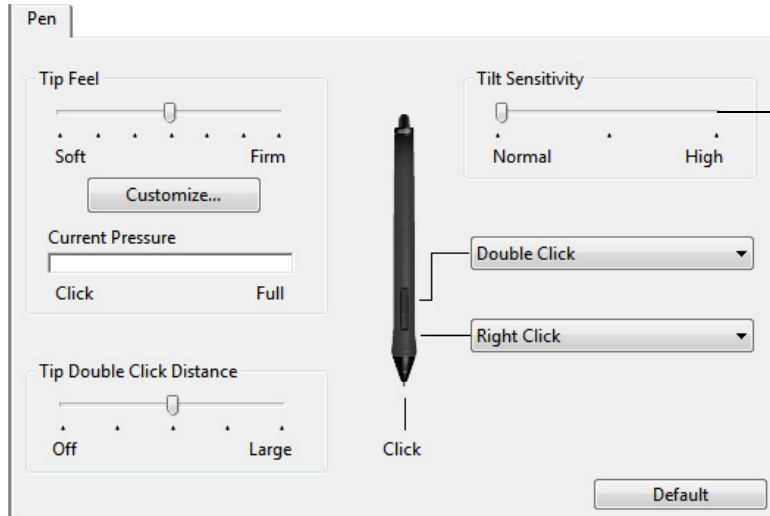

Drag to increase or decrease TILT SENSITIVITY. Test the new setting in an application that supports tilt.

The tilt setting applies to both the tip and eraser of your tool.

Tilt is direction sensitive and can be used in some applications to control brush orientation or other characteristics.

Visit the Wacom web site to learn about applications that currently support tilt.

CUSTOMIZING PEN DISPLAY FUNCTIONS

To customize the interactive pen display, [open](#) the Wacom Tablet control panel and select the FUNCTIONS icon in the TOOL list. Select a tab to customize, and change settings using the available options.

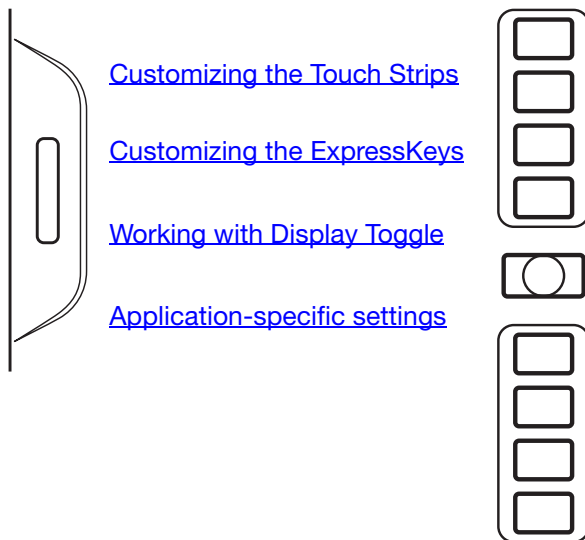

[Customizing the Touch Strips](#)

[Customizing the ExpressKeys](#)

[Working with Display Toggle](#)

[Application-specific settings](#)

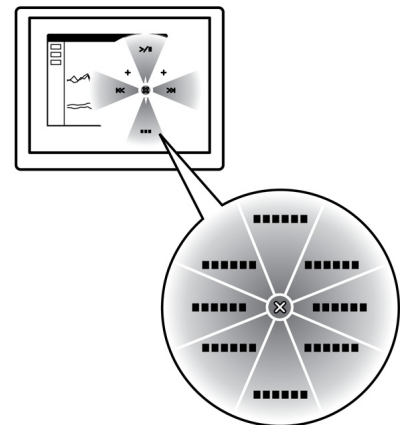

[Using and customizing the Radial Menu](#)

CUSTOMIZING THE EXPRESSKEYS

To customize the ExpressKeys, select the EXPRESSKEYS tab. Each key can be customized to perform a Display Toggle, modifier, keystroke, or other function.

Select LEFT or RIGHT to choose which ExpressKeys to customize.

Choose a [function](#) to perform when the key is pressed.

ExpressKey functions can be defined for use with [specific applications](#).

See [using the ExpressKeys](#) for more information.

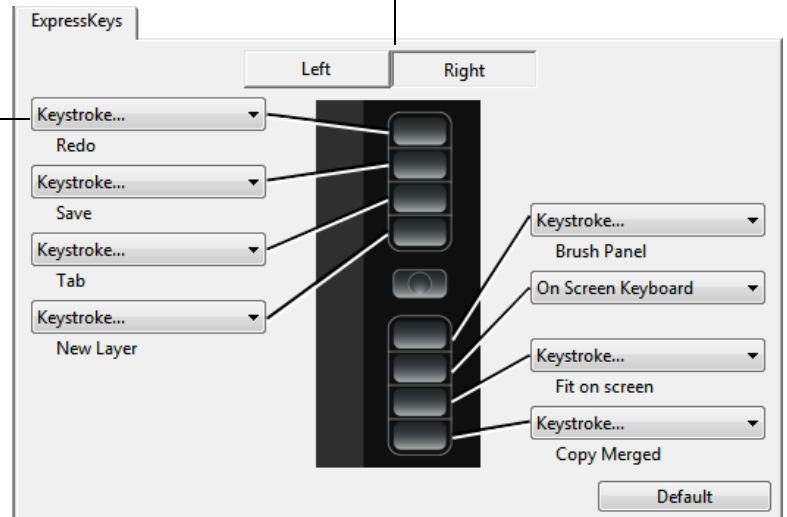

Important: Some applications can override and control the ExpressKey functions. For details, see [using applications integrated for tablet control](#).

CUSTOMIZING THE TOUCH STRIPS

To customize the Touch Strips, select the TOUCH STRIP tab. Touch Strip functions can be modified to perform various zooming, scrolling, or custom keystroke actions. For example, you might set a Touch Strip function to cycle layers when working in Adobe Photoshop. You can also set Touch Strip functions to DISABLED.

Select LEFT or RIGHT to choose which Touch Strip to customize.

Choose a [function](#) to perform when using the Touch Strip. Each Touch Strip can be customized for four different modes.

Adjust SPEED to control the rate at which zooming and scrolling occurs, or the speed at which keystroke events are sent to an application.

Touch Strip functions can be defined for use with [specific applications](#).

See [using the Touch Strips](#) for more information.

Enables or disables display of the Touch Strip settings diagram.

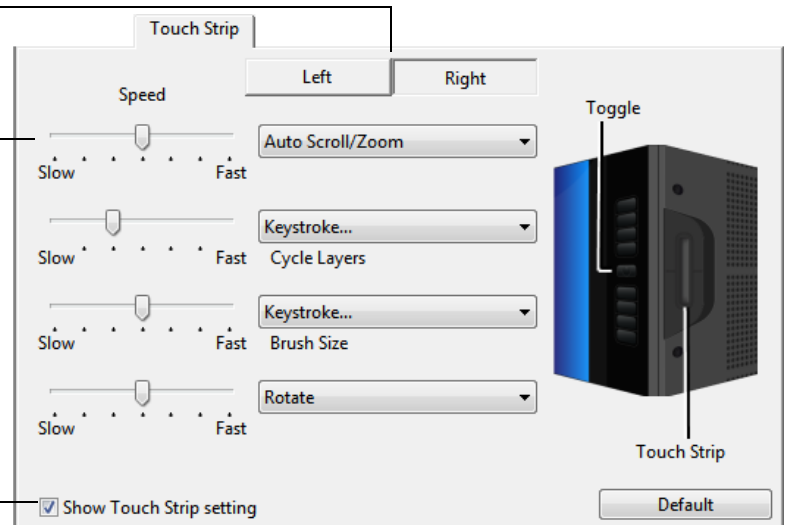

Tips:

- Customize a Touch Strip for other actions by selecting the KEYSTROKE... option and defining a custom [keystroke](#) function. To learn which keystroke shortcuts are supported by a particular application, see the documentation that came with the application.
- Press the Touch Strip Mode button to cycle between Touch Strip functions.
- Choose SKIP to set the Touch Strip Mode button to skip the function state.
- To zoom images at the current position of the screen cursor in Adobe Photoshop CS3 or later, open the Adobe Photoshop general preferences pane. Check the ZOOM WITH SCROLL WHEEL option and click OK.

Important: Some applications can override and control the Touch Strip functions. For details, see [using applications integrated for tablet control](#).

BUTTON FUNCTIONS

Customize Cintiq for the way you like to work. Simply use the Wacom Tablet control panel to change the button function that is assigned to a pen tool button, ExpressKey, Touch Strip, or Radial Menu setting. Button function options may vary, depending on your pen display model. Not all options are available for all controls or pen display models.

FUNCTION NAME	DESCRIPTION
CLICKS	
• CLICK	Simulates a primary mouse button click. Be sure at least one button performs this function so you can always navigate and click.
• RIGHT CLICK	Simulates a right mouse button click, which displays a context menu.
• MIDDLE CLICK	Simulates a middle mouse button click.
• DOUBLE CLICK	Simulates a double-click. For easier double-clicking, use this function instead of tapping twice with the pen tip.
• CLICK LOCK	Simulates holding down the primary mouse button. Press the pen button once to initiate click lock. Press the button again to release click lock. Click lock is useful for dragging objects or selecting blocks of text.
• 4TH CLICK	Simulates a 4th mouse button click.
• 5TH CLICK	Simulates a 5th mouse button click.



FUNCTION NAME

DESCRIPTION

KEYSTROKE...

Enables you to simulate keystrokes. Select this option to display the DEFINE KEYSTROKE dialog box.

Enter a keystroke or keystroke combination in the KEYS entry box. Keystroke combinations can include letters, numbers, function keys (such as F3) and modifier keys (such as SHIFT, ALT, or CTRL for Windows, or SHIFT, OPTION, COMMAND, and CONTROL for Mac). You can also choose special keystrokes or keystroke combinations from the ADD SPECIAL drop-down menu.

After defining a keystroke or keystroke sequence, click OK.

Important: Because the ENTER (Windows) and RETURN (Mac) keys can be selected as a defined keystroke, they cannot be used to select OK. You must use your pen to click on the OK button.

Enter a name for the keystroke definition. The name will be displayed with the respective control or in the Radial Menu, as applicable.

You can create different keystroke functions for different applications. See [application-specific settings](#).

Deletes the last entry in the keystroke entry box.

Clears the entry box.

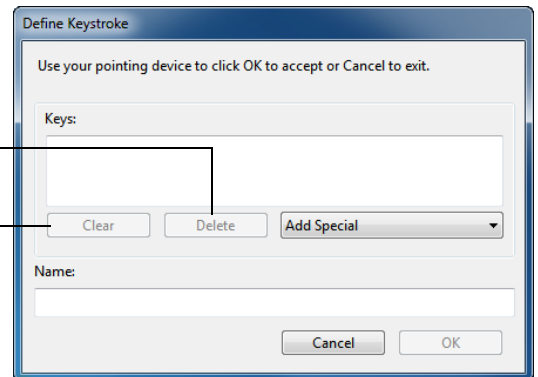

To learn which keystroke shortcuts are supported by a particular application, see the documentation that came with the application.

MODIFIER...

Enables you to simulate modifier key(s) (such as SHIFT, ALT, or CTRL for Windows, or SHIFT, OPTION, COMMAND, and CONTROL for Mac). Many applications use modifier keys to constrain the size or placement of objects.

Choose one or more modifier options.

Choose a CLICKS option to simulate pressing a button of the selected type on a mouse.

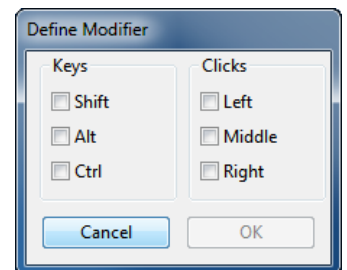

FUNCTION NAME	DESCRIPTION
RADIAL MENU	Displays the Radial Menu on your screen. Each level of the hierarchical menu consists of eight menu slices which may contain various features and options to choose from.
BACK	Simulates the BACK command in browser applications.
FORWARD	Simulates the FORWARD command in browser applications.
PAN/SCROLL...	<p>Enables you to position a document or image in any direction within the active pane. Do this by pressing a pen button set for PAN/SCROLL and then dragging with the pen tip across the pen display screen.</p> <p>When you select PAN/SCROLL, you are prompted to set a scrolling speed for use in applications that do not support grabber hand (pixel-level) panning.</p> <ul style="list-style-type: none"> • A slower setting reduces the scroll rate and is useful for close-up and detail work where you need precise control of the image. • As you move the pen tip, the document or image is repositioned to follow the direction of pen movement on the pen display screen surface. • Release the button or lift the pen tip from the display screen surface when you are done. • In some application windows the document will precisely follow the screen cursor as you move the pen tip, while in others it will simply move in the same general direction as the screen cursor.
SHOW DESKTOP	Minimizes all open windows to display a clean desktop.
SWITCH APPLICATION	Brings up the application switching dialog box with focus on the next open application. On Windows 7 or Vista systems running Aero, Flip 3D will be activated with focus on the next open application.

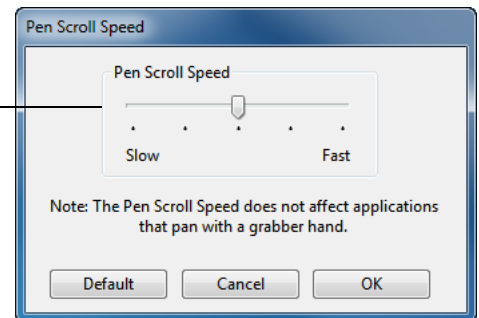

FUNCTION NAME

DESCRIPTION

OPEN/RUN...

Opens a dialog box where you can select a specific application, file, or script to launch.

Click BROWSE... to locate an application, file, or script to launch. The selection you make appears in the NAME box.

Click OK to accept the selection.

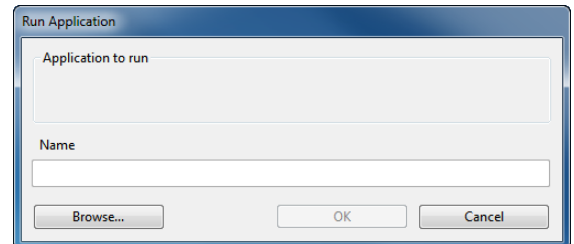

The dialog box will close and the OPEN/RUN... option you have selected will be assigned as the pen button option. Simply press the pen button to launch the assigned option.

If your selection is for the Radial Menu, it will be displayed in the Radial Menu.

INK TOGGLE

(Mac only.) Toggles the “ink in any application” function of Ink on and off. Ink recognizes and converts your handwriting into text and inserts it into a document. Handwriting recognition must be turned on for this function to work. See your Mac help for information on working with Ink.

ON SCREEN KEYBOARD

Launches the on-screen keyboard when you press the button to which this function is assigned. Press the button to close the keyboard when open.

EXPOSÉ

(Mac only.) Tiles all open windows. To access this option, first choose KEYSTROKE... and then click on the ADD SPECIAL menu within the dialog box.

PRESSURE HOLD

Locks the pressure at the current pressure level until the button is released. For example, you can paint with pressure sensitivity until you reach the brush size that you like. You can then press the button and continue painting with the same size brush until the button is released.



FUNCTION NAME	DESCRIPTION
PRECISION MODE	<p>Changes the mapping around the current pen tip position so that you must move the pen farther for the screen cursor to cover a specific distance on the display screen. This feature can be very useful for the precise control of pen or brush strokes.</p> <p>You can adjust the precision setting when assigning this function to a tool button.</p> <p>To activate:</p> <ul style="list-style-type: none"> • <u>For extensive use</u>, toggle on PRECISION MODE by pressing a tool button to which the function has been assigned. Return to normal mapping by again pressing the tool button. • <u>For quick edits</u>, press and hold a tool button to which the function has been assigned. Normal mapping returns when you release the button. <p>When using a tool in mouse mode, screen cursor movement is adjusted to act as if acceleration were off and speed set to slow.</p>
DISPLAY TOGGLE	<p>Available when Cintiq is connected as part of a multiple monitor system. Enables you to toggle the screen cursor between the Cintiq pen display and your other displays. For example: Cintiq can be used as a pen display where the screen cursor is positioned at the pen tip location on the pen display screen surface. Display Toggle enables you to cycle between pen control for Cintiq and your other displays. This is like using Cintiq as a standard Wacom tablet where the screen cursor can be moved across the entire desktop or additional displays.</p>

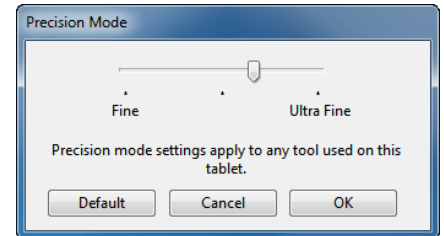

FUNCTION NAME	DESCRIPTION
MODE TOGGLE...	<p>Toggles between pen mode and mouse mode. When using Cintiq on a multiple monitor system, this enables you to use your pen to control the other monitors in mouse mode.</p> <p>When first setting a pen button to MODE TOGGLE..., the MOUSE MODE dialog box is displayed where you can adjust the mouse acceleration and speed.</p> <p>Sets the screen cursor tracking speed when in mouse mode.</p> <p>Sets the screen cursor acceleration when in mouse mode.</p>
ERASE	<p>Pen only. Sets a button so that when the button is pressed, the pen tip will act like the eraser in applications that support the ERASE function. Default setting for the eraser. See erasing.</p>

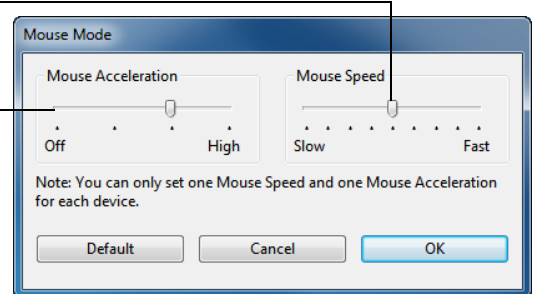

FUNCTION NAME	DESCRIPTION
SETTINGS	Activates (on your display screen) an interactive diagram of the current ExpressKey, Touch Strip, and pen settings. The current functions for each control are shown.

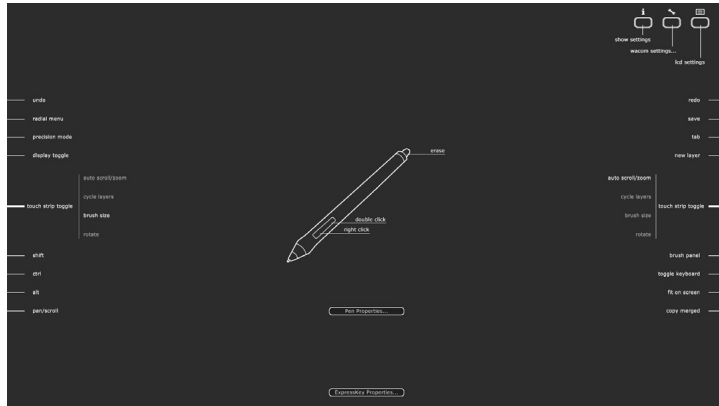

Click on any section of the diagram to open the appropriate Wacom Tablet control panel tab. You can then adjust settings as needed.

Dismiss the diagram by again pressing the ExpressKey or other tool button to which this function is assigned, or by clicking anywhere outside of the diagram.

Settings may vary depending on your product model.

TABLET PC

- **TABLET PC INPUT PANEL** (Tablet PCs and Windows systems that support the Tablet PC Input Panel.) Opens the Tablet PC input panel when you press a tool button set to this function.
- **JOURNAL** (Windows 7 and Vista, and Tablet PC systems that include Microsoft Journal.) Opens Microsoft Journal.
- **TABLET PC DEFINED** (Tablet PCs and Windows systems that support the Tablet PC Input Panel.) Sets the button function according to settings found in the:
 - Windows 7 and Vista **TABLET PC SETTINGS** and **PEN AND INPUT DEVICES** control panels.
 - Windows XP Tablet Edition **TABLET AND PEN SETTINGS** control panel.

DISABLED

Disables the button function.

APPLICATION DEFINED

Reports only the button number to the application. This is for applications, such as CAD programs, that have built-in tablet support.

DEFAULT

Returns a button to its default setting.

USING AND CUSTOMIZING THE RADIAL MENU

The Radial Menu is a pop-up menu that provides quick access to editing, navigation, media control functions, and more.

- Set a tool button or ExpressKey to the RADIAL MENU function. Press the button to display the Radial Menu centered at the screen cursor position.
- The hierarchical Radial Menu appears in circular format. Each level of the menu consists of eight control slices which may contain various features and options to choose from.
- Click to select an option. Some selections may display a submenu for additional options.
- The menu closes after you make a selection.
To close without making a selection, click on the 'X' located at the center of the Radial Menu or on a control slice that has no function assigned to it. You can also again press the button used to display the menu.
- To make a selection without closing the Radial Menu, hold down the button that opens the Radial Menu.

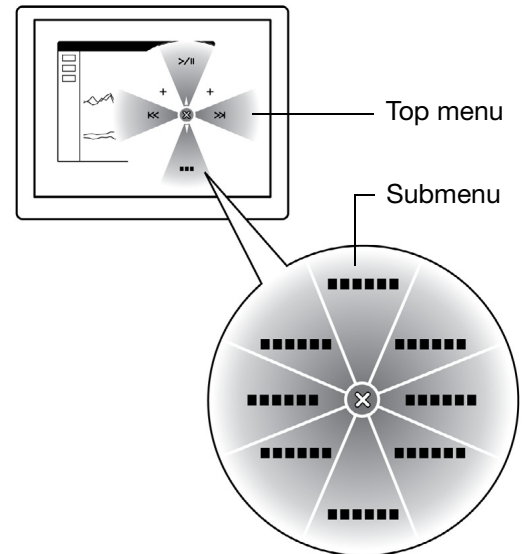

In the Wacom Tablet control panel, use the RADIAL MENU tab to customize the available Radial Menu functions.

1. Select a control slice.
2. Assign a control FUNCTION to the slice. If desired, change the LABEL name.
3. Select a menu or submenu to further customize.

Tips:

- In the FUNCTION menu, choose SUBMENU to create custom submenus for a control slice.
- Press the ENTER (RETURN) key to add multiple lines of LABEL text.

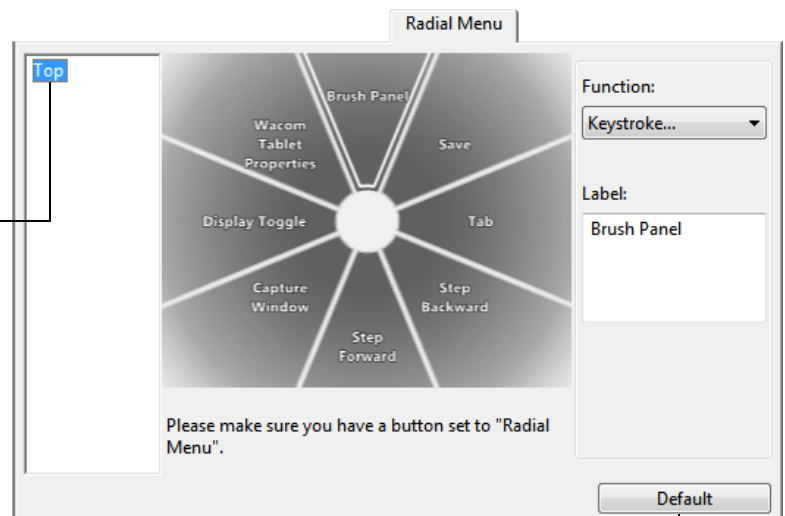

Returns the currently displayed menu to its default values.

WORKING WITH DISPLAY TOGGLE

A Display Toggle feature is available only on multiple monitor systems. Set an ExpressKey or pen side switch to the DISPLAY TOGGLE function. Then press that button to toggle the screen cursor between Cintiq and your other displays. For example, Cintiq can be used as a pen display where the cursor is positioned at the pen tip location, or toggled for use as a standard Wacom tablet where the cursor can be moved across the entire desktop or any display on your system.

Open the Wacom Tablet control panel and make sure Cintiq is the selected TABLET. The DISPLAY TOGGLE tab will be available if the system has two or more displays. The options on this tab define how the tablet mapping is applied to each toggled display.

- PEN DISPLAY TO DESKTOP toggles the screen cursor from Cintiq to the entire system desktop. Press the button a second time to return the cursor to Cintiq.
- PEN DISPLAY TO OTHER DISPLAYS toggles the screen cursor from Cintiq to another active pen display or monitor. The cursor toggles to each connected display in turn until it returns to the Cintiq from where the initial toggle began.

Important: When using application-specific settings with Display Toggle, be sure each customized application (including ALL OTHER) has a tool button to which DISPLAY TOGGLE has been assigned. The easiest way to do this is to assign DISPLAY TOGGLE to an ExpressKey before creating any application-specific settings.

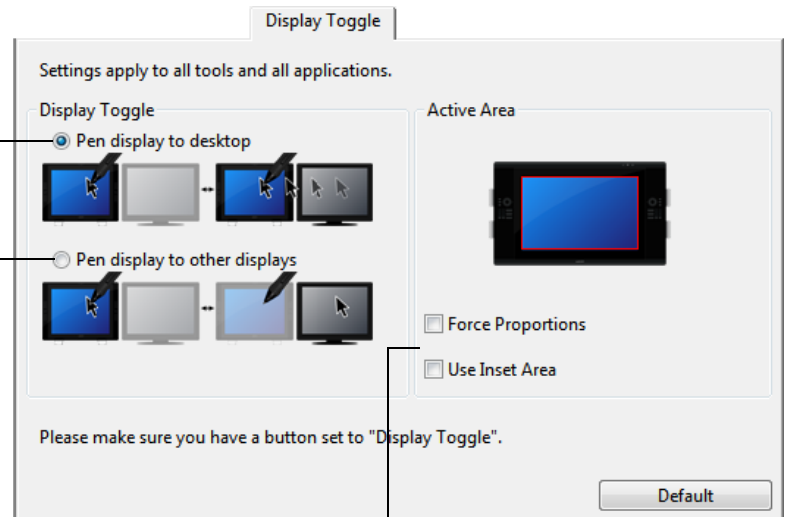

ACTIVE AREA options determine the size of the area where the pen will function on the pen display.

- FORCE PROPORTIONS adjusts the size of the active area to maintain correct vertical and horizontal proportions between Cintiq and the entire desktop or newly mapped-to display. Depending on your settings, some portions of the active area may no longer be usable when this option is selected. When deselected, the correct scale or proportions are not maintained. For example, drawing a circle on the pen display may create an ellipse on a mapped-to display screen.
- USE INSET AREA limits the active area to a sizing of 6 x 8 inches. If FORCE PROPORTIONS is also selected, this sizing may be less. When deselected, as much of the active area as possible will be used for tablet-to-display mapping.

Your selection is shown by the red box in the ACTIVE AREA diagram.

APPLICATION-SPECIFIC SETTINGS

You can customize your tools for use with a particular application. For example, you may prefer a firm pen tip pressure setting in one application and a soft pressure setting in another. The APPLICATION list enables you to add an individual application to the list and then customize your tool settings for that application.

- When no application-specific settings have been created and a tool is selected from the TOOL list, the APPLICATION list displays the ALL icon which contains tool settings that apply to all of your applications. In the example below, no application-specific settings have been added for the GRIP PEN. The ALL icon is displayed and the GRIP PEN will have the same settings in all applications.

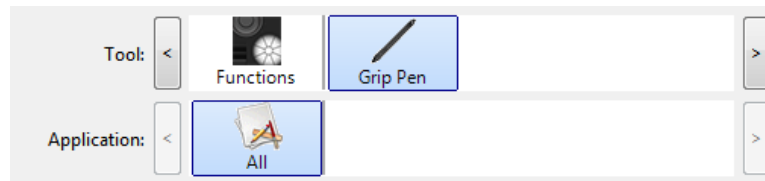

- When application-specific settings are added, the ALL icon changes to ALL OTHER and an application icon is displayed for the newly added application(s).

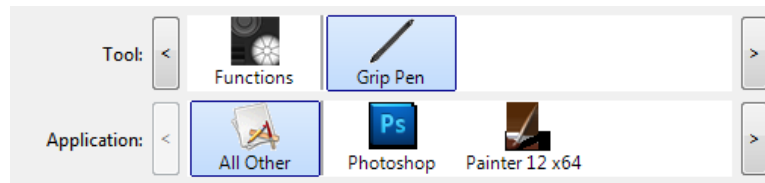

In the above example, application-specific settings have been added for the GRIP PEN. If you select the ALL OTHER icon and make changes to the GRIP PEN settings, your changes will apply to the GRIP PEN in all applications except those which you have added to the APPLICATION list. If you select an application icon and make changes to the GRIP PEN settings, your changes will apply to the GRIP PEN while you are using that application only.

When you create application-specific settings, you are creating a separate group of settings for the selected tool and application. See the following sections for more details:

[Creating an application-specific setting](#)

[Changing application-specific settings](#)

[Removing application-specific settings](#)

Tip: To review ExpressKey, Touch Strip, or pen function settings for the front-most application, set an ExpressKey to SETTINGS and press the key at any time.

CREATING AN APPLICATION-SPECIFIC SETTING

First choose the pen display and input tool for which you want to create an application-specific setting.

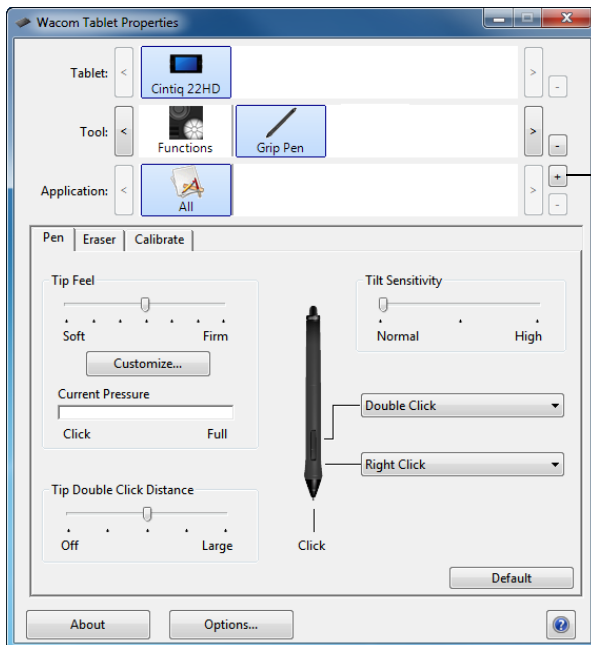

Click on the APPLICATION list [+] button.

Choose a method to select an application:

- Open the application for which you want to create custom settings, and then select that application from the CURRENTLY OPEN APPLICATIONS box.
- BROWSE to select the executable file of any application installed on your computer.

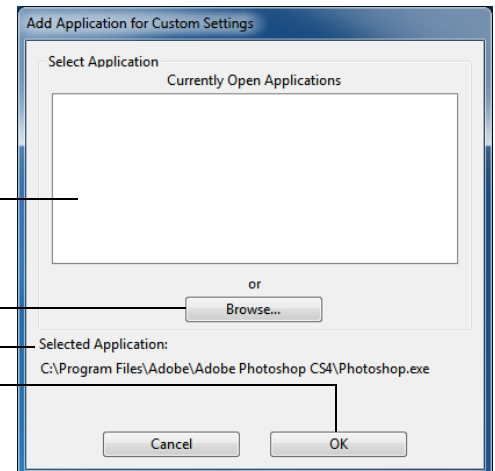

The name of your selected application is displayed.

Click OK to complete the process.

Note: If two programs have the same executable file name, they will share the same customized settings.

After adding an application, its icon appears in the APPLICATION list whenever the respective tool is selected in the TOOL list. Select the application and then customize the control panel tab settings for your tool and selected application.

Once you have created application-specific settings, applications that have not been customized in this manner will use the tool settings for ALL OTHER.

Tip: First customize settings for one application. When you feel comfortable with the process, you can create more application-specific settings.

CHANGING APPLICATION-SPECIFIC SETTINGS

To change tool settings for a specific application, select the tool and the application. Then customize the tab settings.

REMOVING APPLICATION-SPECIFIC SETTINGS

To remove an application-specific setting:

1. In the TOOL list, select the tool from which you want to remove the application-specific setting. Then, in the APPLICATION list select the application you want to remove from the list.
2. Click on the APPLICATION list [-] button. In the dialog box that appears, click DELETE to confirm your selection. The selected application is removed from the list, along with any custom tool settings.

Tip: To quickly remove all application-specific settings from a single tool, remove it from the TOOL list. Then place the tool back on the pen display. The tool will be added back to the TOOL list using the default settings. This method cannot be used to remove custom FUNCTIONS settings. See [working with multiple tools](#).

WORKING WITH MULTIPLE TOOLS

The Wacom Tablet control panel is designed to help you customize and keep track of the settings for your Cintiq tools. The tool you use to open the control panel is automatically selected, and the appropriate tabs for that tool are displayed.

The TOOL list displays an icon for the pen display FUNCTIONS and different tools that have been used on the pen display.

If application-specific settings have not been added, the ALL icon is displayed and the tool settings apply to all applications.

Tab settings apply only to the selected tool and application.

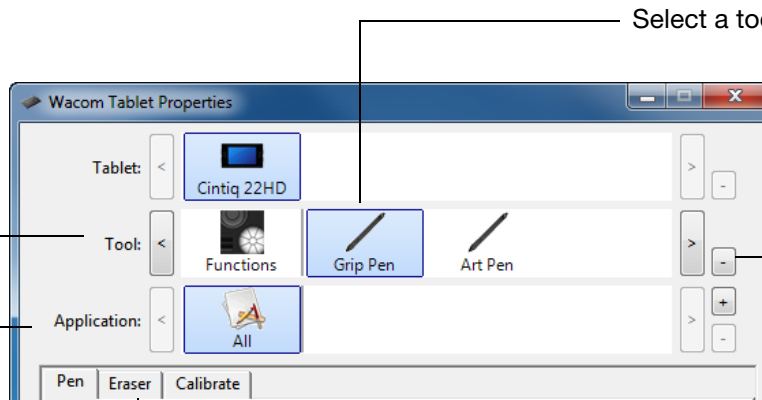

Select a tool to change its settings.

Removes the selected tool.

The button is inactive when there is only one item in the list.

The FUNCTIONS icon cannot be deleted.

To add a different tool to the TOOL list, simply use the tool on your interactive pen display.

- When you select a tool that has been added to the TOOL list, the appropriate tab settings for that tool are displayed. Any changes you make to the tab settings will then apply to the tool. Your changes take effect immediately.

If a similar tool was previously added, the new tool will inherit the settings of the previously added tool. These settings can then be customized for the newly added tool.

- Identical tools will use the same settings.

To remove a selected tool from the TOOL list, click on the TOOL list [-] button. In the dialog box that appears, click DELETE to confirm your selection. The selected tool is removed from the list, along with any custom settings you may have created for it. A removed tool can be added back to the TOOL list by placing it back onto the pen display screen.

RENAMING THE TABLET IN THE TABLET LIST

Within the control panel TABLET list, double-click on the pen display icon.

If desired, enter a new name to be used for the pen display icon.

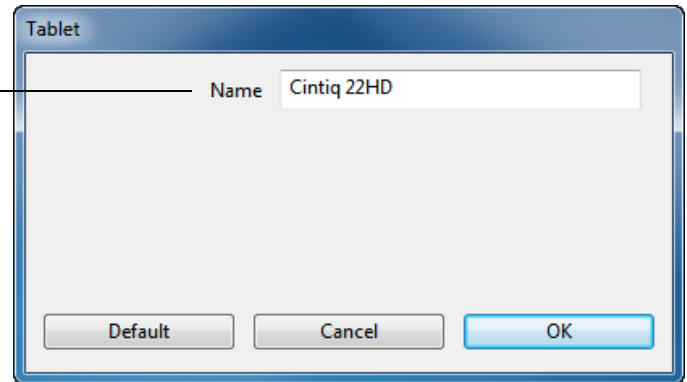

TROUBLESHOOTING

If you are having trouble, Wacom recommends you do the following:

1. If the Wacom driver failed to load properly, first perform the recommended action in any error message that may appear on your screen. If that does not solve the problem, review the troubleshooting procedures in this chapter.
2. If Cintiq does not function properly, refer to [display troubleshooting](#) or [pen tablet troubleshooting](#). Your problem may be described there and you can try the solution offered.
3. Open the Wacom pen display Read Me file and look for any information updates.
4. Visit www.wacom.com and choose the Wacom web site for your region where you can check the product FAQs ([Frequently Asked Questions](#)).
5. If you are having a compatibility conflict between Cintiq and a new hardware or software product, see [obtaining software updates](#) for information on downloading an updated software driver. Wacom periodically updates the software driver to maintain compatibility with new products.
6. Try [testing Cintiq](#).
7. If you have tried the suggestions in this manual and still cannot resolve the problem, then contact Wacom for Technical Support. See the [technical support options](#) and the Read Me file for information on where to obtain support for your region.

[Testing Cintiq](#)

[Testing controls and input tools](#)

[Display troubleshooting](#)

[Pen tablet troubleshooting](#)

[Technical support options](#)

[Obtaining software updates](#)

TESTING CINTIQ

1. If the Cintiq power LED does not light, check the following:
 - First verify that the light on the power adapter is on. If the light is not on, check that the power cable is properly connected between the power adapter and an active AC outlet.
 - Check that the power adapter cable is securely connected to the Cintiq power cable and that the pen display is turned on. The power LED will glow orange or blue whenever the pen display is on.

Important: Use only an AC adapter specified for use with your pen display. Other adapters may cause damage to your product.
2. If there is no display:
 - Make sure that your computer is turned on. The power LED will glow blue when the proper video signal is received. It will glow orange if there is no video signal or if the computer is in a power saving mode.
 - Verify that the pen display is connected to an active digital (DVI) or analog (VGA) video port.
 - Check that your video card has been properly installed and is functional. If you have another display that is compatible with your video card, you can connect that display to the card in order to verify that the video card is operating correctly.
3. Verify that the pen and the tablet portion of your pen display are working:
 - Press the pen tip against the display and verify that the status LED lights blue.
 - If the LED does not light, verify that the USB cable is plugged into an active USB port. If Cintiq is plugged into a USB hub, try plugging it directly into the USB port on your computer.
 - Be sure that the USB port to which you are connecting has not been disabled. It may be necessary to check your system BIOS setting to verify that you have connected the pen display to an active USB port.
 - The status LED will light blue when Cintiq is registered as a USB device and the pen tip is pressed against the display.
4. Check the pen. If you cannot make a selection on the display screen with the pen:
 - Test the pen by pressing the pen tip or eraser against the surface of the pen display. The status LED should light blue.
 - Now, without applying pressure to the pen tip but keeping the pen within 5 mm (0.2 inch) of the pen display surface, press the side switch. The status LED should again light blue.
 - If the status LED does not light blue for these tests, be sure you are using a pen specified for use with your product.
 - See [testing controls and input tools](#) and [testing a pen](#) for more information.





5. Check the hardware control buttons. See [testing controls and input tools](#) and [testing the hardware control buttons](#).
6. Check the ExpressKeys. See [testing controls and input tools](#) and [testing the ExpressKeys](#).
7. Check the Touch Strips. See [testing controls and input tools](#) and [testing the Touch Strips](#).
8. Check any other tool(s), such as the optional Airbrush. See [testing controls and input tools](#).

If you are still having problems, you may have a defective pen or pen display.

After testing, use the Wacom Tablet control panel to reconfigure your tablet and tools for any custom settings you may originally have been using.



TESTING CONTROLS AND INPUT TOOLS

If the Grip Pen or the Cintiq controls do not work as you expect, it is a good idea to first check the assigned functions or reset them to their default conditions.

A quick way to return a pen to its default condition is to remove it from the control panel TOOL list. Do this by selecting the pen and clicking on the TOOL list [–] button. After the pen has been removed, place it back onto the display screen surface. The pen will be added back to the TOOL list with its default settings.

- Open the Wacom Tablet control panel and click on the ABOUT button. In the dialog box that appears, click DIAGNOSE.... The DIAGNOSTICS dialog box shows dynamic information about the Cintiq pen display and your input tool(s).

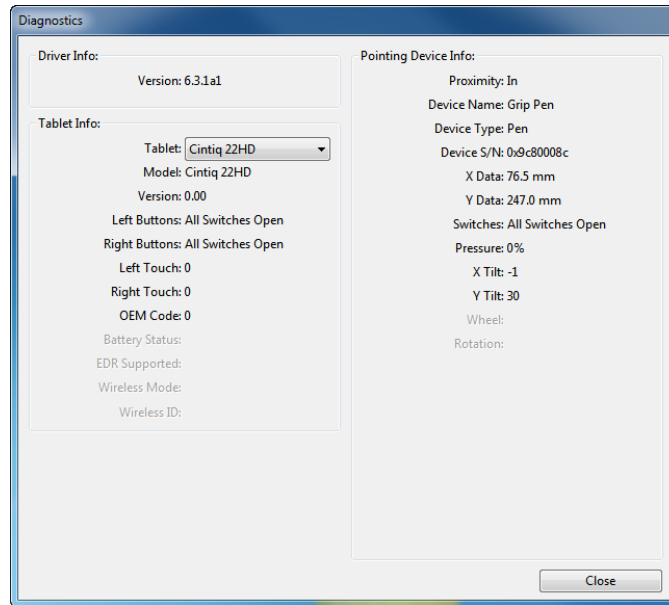

- If more than one pen display or tablet is connected to your system, in the TABLET INFO column select the product you are testing.
- Use the information shown in the DIAGNOSTICS dialog box when testing your pen display and pen.

Note: If a tool button is set to RADIAL MENU or OPEN/RUN..., that function will occur when the button is pressed. In this case you may want to change the button function before testing.

[Testing the hardware control buttons](#)

[Testing the ExpressKeys](#)

[Testing the Touch Strips](#)

[Testing a pen](#)

TESTING THE HARDWARE CONTROL BUTTONS

1. With the DIAGNOSTICS dialog box open, observe the TABLET INFO column as you test each of the three hardware control buttons located on the upper front of your interactive pen display. Be sure to select the pen display you are testing from the TABLET INFO column.
2. Test the buttons by pressing them one at a time. Each time you press a button, its number is shown next to the either the LEFT BUTTONS or RIGHT BUTTONS category.
3. When you are done, click the CLOSE button to exit the dialog box.

TESTING THE EXPRESSKEYS

1. With the DIAGNOSTICS dialog box open, observe the TABLET INFO column as you test each ExpressKey. Be sure to select the pen display you are testing from the TABLET INFO column.
2. Test the keys by pressing them one at a time. Each time you press a key, its number is shown next to either the LEFT BUTTONS or RIGHT BUTTONS category, depending on which keys group you are testing.
3. When you are done, click the CLOSE button to exit the dialog box.

Important: Some applications can override and control the ExpressKey functions. Consider closing any open applications except the Wacom Tablet control panel when testing the ExpressKeys. For details, see [using applications integrated for tablet control](#).

TESTING THE TOUCH STRIPS

1. With the DIAGNOSTICS dialog box open, observe the TABLET INFO column as you test each Touch Strip. Be sure to select the pen display you are testing from the TABLET INFO column.
2. Slide your finger up or down along the entire length each Touch Strip. A number is shown next to either the LEFT TOUCH or RIGHT TOUCH category, depending on which Touch Strip you are testing.
3. Press the corresponding Touch Strip Mode button for the Touch Strip you are testing. This will toggle between the customizable states of the Touch Strip. As you toggle, an overlay will appear briefly on your display screen to show the function assignments. Within the DIAGNOSTICS dialog box, the button state will also be shown.

If any of the functions are set to SKIP, that function will be skipped in the toggle sequence.

4. When you are done, click on the CLOSE button to exit the dialog box.

Important: Some applications can override and control the Touch Strip functions. Consider closing any open applications except the Wacom Tablet control panel when testing the Touch Strip. For details, see [using applications integrated for tablet control](#).

TESTING A PEN

1. With the DIAGNOSTICS dialog box open, and while observing the POINTING DEVICE INFO column, bring your pen within 5 mm (0.2 inch) of the display screen. A value for PROXIMITY, the DEVICE NAME, DEVICE TYPE, and a DEVICE S/N (serial number) should be displayed. Be sure to select the pen display you are testing from the TABLET INFO column.
2. Move your tool along the pen display screen surface. The X and Y DATA values should change to reflect the tool position.
3. Test your pen switches. The Cintiq status LED should light blue each time you click with the tool tip, press the side switch, or press the tool eraser to the display screen.
 - Press on the display screen surface with the tool tip. The SWITCHES state and PRESSURE value should change. PRESSURE should change from approximately 0% with no pressure applied to approximately 100% when full pressure is applied.
 - Next, press the side switch without pressing the tip to the tablet. The SWITCHES state should change. For the Grip Pen, do this for both positions of the switch.

Pen	Tip = 1
SWITCHES states	Side switch (lower position) = 2
	Side switch (upper position) = 3
	Eraser = 1

Airbrush	Tip = 1
SWITCHES states	Side switch = 2
	Eraser = 1

- Press the eraser to the display screen. The SWITCHES state and PRESSURE value should change. PRESSURE should change from approximately 0% with no pressure applied to approximately 100% when full pressure is applied.
 - For the optional Airbrush, move the fingerwheel forward. The WHEEL value should decrease to a value of approximately 0 when the fingerwheel is all the way forward. Move the fingerwheel backward. The WHEEL value should increase to approximately 1000 when the fingerwheel is all the way back.
4. Test tilt for the x-axis by moving the pen from a vertical position toward the right; the X TILT value should change from approximately 0 to +60. Now move the tool to the left of vertical; the X TILT value should change from approximately 0 to - 60.
 5. Test the tilt for the y-axis by moving the pen from a vertical position toward the bottom of the tablet; the Y TILT value should change from approximately 0 to +60. Now move the tool toward the top of the tablet; the Y TILT value should change from approximately 0 to - 60.
 6. For the optional Art Pen, test the rotation feature by placing the pen tip on the display screen surface and slowly rotating the pen on its axis. The ROTATION value should change as you rotate the pen.
 7. When you are done, click on the CLOSE button to exit the dialog box.

DISPLAY TROUBLESHOOTING

If you encounter problems with the display portion of the interactive pen display, refer to the following tables. Your problem may be described here and you can try the solution offered. For more information about color issues, see the documentation that came with your operating system or applications.

[General display problems](#)

[VGA problems](#)

GENERAL DISPLAY PROBLEMS

No display. Power LED is off.	Verify the AC power cable is connected, and that the pen display is turned on.
No display. Power LED is lit blue.	Check the contrast, brightness, and backlight controls. Adjust as necessary. Or, open the OSD menu and choose OTHER SETTINGS and RESET.
The power LED is lit orange. A 'no signal go to power save' message appears briefly on the display screen.	<ul style="list-style-type: none"> Your computer may be in a power management mode. Touch the pen tip to the display screen, move the mouse, or depress any key on your keyboard. Turn off both your computer and the pen display. Check the video cable for bent or broken connector pins. Then properly connect the video cable and turn on the pen display and your computer. Verify that the video card is properly installed.
A 'cable disconnect go to power save' message appears briefly on the display screen.	<ul style="list-style-type: none"> Check that your computer is turned on. Verify that you are using the video cable that came with the pen display. Check that the video cable is fully connected. Turn off both your computer and the pen display. Check the video cable and any video adapters for bent or broken connector pins. Then properly connect the video cable and any necessary adapters.



An 'out of range' message appears briefly on the display screen.

- The input signal frequency is incorrectly set or not compatible with the pen display. Set the refresh rate to a vertical frequency that is compatible with your pen display. If your video card driver supports adjustment of the horizontal frequency, make sure it is also set to a compatible value. See the Important Product Information guide for frequency range details. On a single monitor system you will need to connect a different display to change the refresh rate.
- The resolution or refresh rate is set too high. See the Important Product Information guide for details about the maximum (native) resolution, refresh rate, and other resolution sizes that can be used with your pen display.
- Set the display properties to detect plug and play monitors.

A 'set refresh range' message appears briefly on the display screen.

- Set the refresh rate to a vertical frequency that is compatible with your pen display. See the Important Product Information guide for frequency range details.

The image appears multiple times on the display.

Do not extend the video cable or use an input selector switch box.

When a still image is displayed for a long period of time without refreshing the screen, an after-image remains for a short period of time.

Use a screen saver or other power management feature.

Color quality is inaccurate.

- Press the LCD settings button to open the OSD menu. Choose OTHER SETTINGS and RESET.
- Check the color profile settings that you are using with Cintiq.
- Any changes to the contrast setting should be made in small increments as changes in contrast may affect color accuracy.

The color white does not display as white.

- Check the color profile settings that you are using with Cintiq.
- Verify that the display is operating at the factory default settings. If that is not sufficient, then adjust color as necessary. For details on color management, refer to your operating system and application documentation.
- Verify the video cable and port are fully connected.



VGA PROBLEMS

The display ripples or flickers.

- Press the LCD settings button to open the OSD menu. Choose VGA SETTINGS and AUTO ADJUST. Then, if necessary, manually adjust pitch and phase.
- Verify that the display adapter or video card matches the specifications for the interactive pen display.
- Adjust the refresh rate in the display properties control panel.

The display is not clear. Text or other portions of the screen appear blurred.

- Set the display resolution of your video card to the maximum (native) resolution that can be used with your pen display. See the Important Product Information guide for details.
- Turn off the pen display, then turn it back on.
- Open the OSD menu. Choose VGA SETTINGS and AUTO ADJUST. If necessary, manually adjust the brightness, pitch, and phase settings.

The display and LCD panel are not lined up. The display size is not correct.

- Open the OSD menu. Choose VGA SETTINGS and AUTO ADJUST.
- As necessary, adjust pitch and phase, and horizontal and vertical position. Note that some video cards may not show the display in proper sizing.

The display ripples or shows a moiré pattern. The display color is not even.

- Open the OSD menu. Choose VGA SETTINGS and AUTO ADJUST. If this does not solve the problem, choose OTHER SETTINGS and RESET to return the display back to the factory default settings.
- As necessary, adjust pitch and phase.





PEN TABLET TROUBLESHOOTING

If you encounter problems with the tablet portion of the interactive pen display, see the following tables. Your problem may be described here, and you can try the solution offered. See the pen display Read Me file for the latest information updates.

For additional information, visit the Wacom web site at <http://www.wacom.com>.

[General problems](#)

[Windows-specific problems](#)

[Mac-specific problems](#)

GENERAL PROBLEMS

The computer does not have an available USB port.	Check if there is an available USB port on a USB hub. If not available you will need to add a USB hub or USB card.
A USB device plugged into the pen display USB accessory port does not function.	<ol style="list-style-type: none"> 1. Make sure the pen display itself is properly connected to a working USB port on your computer. 2. Be sure the pen display is powered on and that the power LED lights blue. The pen display contains a powered USB hub and the accessory port will not work when the power is off. 3. If the USB device does not work, try plugging it into a USB port directly on your computer. 4. If the USB device still does not function properly, contact the manufacturer for that particular device.
The Cintiq power LED is off.	<p>Make sure the pen display is turned on.</p> <p>Check that the AC power adapter is plugged into both the pen display and an active power outlet.</p> <p>Use only a power adapter specified for use with your pen display. Other adapters may cause damage to your product.</p>
The pen works only in mouse mode, and does not draw or write with pressure sensitivity.	<p>The driver software for the tablet portion of the pen display was not installed or did not load properly.</p> <ul style="list-style-type: none"> • Make sure the driver software is installed and functioning. • Install the driver software in accordance with step 2: software installation.
The pen does not draw or write with pressure sensitivity.	<p>Some applications require that you turn on the pressure capabilities within the application or selected tool before the pen will respond as a pressure-sensitive tool.</p> <p>Verify also that your application supports pressure sensitivity.</p>
Clicking is difficult.	Open the Wacom Tablet control panel and go to the PEN tab. Try using a lighter TIP FEEL.



The pen selects everything or will not stop drawing.

Open the Wacom Tablet control panel and go to the PEN tab. Move the TIP FEEL slider toward FIRM, or select CUSTOMIZE... and increase the CLICK THRESHOLD setting. If this does not help, see [testing controls and input tools](#).

Double-clicking is difficult.

Be sure you are quickly tapping the display screen twice in the same place. Wacom recommends using the side switch to double-click. Open the Wacom Tablet control panel and go to the PEN tab. Try increasing the TIP DOUBLE CLICK DISTANCE or using a lighter TIP FEEL. Set an ExpressKey to DOUBLE CLICK and use it to issue double-clicks. **Windows:** Try setting your system to launch programs with a single click. See [clicking](#).

The eraser selects everything or will not stop erasing.

Open the Wacom Tablet control panel and go to the ERASER tab. Move the ERASER FEEL slider toward FIRM, or select CUSTOMIZE... and increase the CLICK THRESHOLD setting. If this does not help, see [testing controls and input tools](#).

You notice a delay at the beginning of pen or inking strokes.

Open the Wacom Tablet control panel and go to the PEN tab. Try decreasing the TIP DOUBLE CLICK DISTANCE. If that does not work, move the TIP DOUBLE CLICK DISTANCE slider to the OFF position in order to turn off double-click assist.

You have to press hard with the pen when clicking, drawing, or writing.

Open the Wacom Tablet control panel and go to the PEN tab. Move the TIP FEEL slider toward SOFT, or select CUSTOMIZE... and decrease the SENSITIVITY and CLICK THRESHOLD settings.

The pen tip does not function.

Be sure you are using only the pen that came with your product, or a Wacom accessory pen specified for use with the Cintiq 22HD. Other pens may not function properly on the pen display. Check the control panel PEN tab and verify that a CLICK function is assigned to the pen tip. Make sure the status LED lights blue when the tip is pressed. If the LED does not light, verify that the USB cable is plugged into an active port on your computer or on a USB hub. If the LED still does not light, you may have defective hardware (see [troubleshooting](#)).

The pen tip and screen cursor do not properly line up.

Open the Wacom Tablet control panel and select the CALIBRATE tab. Continue with [calibrating the pen display](#).

Changing the function settings for an input tool has no effect.

Make sure you change the settings for the tool and application that you are using. See [application-specific settings](#) and [working with multiple tools](#).



The pen side switch does not work.

Be sure you are using only the pen that came with your product, or a Wacom accessory pen specified for use with the Cintiq 22HD. Other pens may not function properly on the pen display.

Be sure to press the side switch when the pen tip is within 5 mm (0.2 inch) of the pen display active area. Do this without pressing down on the pen tip.

In the Wacom Tablet control panel, verify that the side switch is set to the proper function you are expecting to occur for the application and tool you are using.

Check also the SIDE SWITCH MODE. If CLICK & TAP is selected, you will need to first press the side switch then touch the pen tip to the pen display screen surface in order to perform a click function.

Make sure the status LED lights blue when you press the side switch. If not, verify that the USB cable is plugged into an active USB port on your computer or on a USB hub. The LED will not light if the USB cable is not plugged into an active port.

If the LED does not light, you may have defective hardware (see [troubleshooting](#)).

The screen cursor moves but it does not jump to the pen tip location when placed on the display screen, and it does not follow the pen tip when moving the pen across the display.

Make sure the Wacom driver has loaded properly by opening the Wacom Tablet control panel. If the driver did not load you will see an error message. If an error message appears, reboot your computer. If the problem persists, refer to [step 2: software installation](#) and reinstall the Wacom driver software. (For Mac, you must restart your computer after installing the Wacom driver for proper operation.)

If you have customized the side switch on your pen to toggle between pen mode and mouse mode, make sure that your pen display is operating in pen mode.

When using Cintiq on a multiple monitor system, you cannot use the pen to control the other monitor(s).

Cycle between pen control for Cintiq and your other displays by pressing an ExpressKey or pen button that is set to [DISPLAY TOGGLE](#).

You can also use your pen to control the other monitors in mouse mode. To use mouse mode, first set a pen button to MODE TOGGLE.... Then use the button to toggle between pen mode and mouse mode.





The line you are drawing does not line up with the location of the screen cursor.

To function properly, some applications require that the pen be set to pen mode. Make sure the pen has not been toggled to mouse mode. If you have set the pen to pen mode and the problem still exists, then you may have a corrupted preferences file. Follow the instructions in [Windows-specific problems](#) or [Mac-specific problems](#) to create a new preferences file.

The computer does not go to sleep.

When you are not using the pen, remove it from the pen display surface or Cintiq will continue to send data, keeping the computer awake.

The screen cursor jumps back when using your regular mouse or trackball.

When not in use, place the pen in the pen stand or in some other location near the pen display. Do not leave the pen on the display. Leaving your pen on the display may interfere with screen cursor positioning when using other input devices.

The screen cursor moves erratically or jumps around on the display screen when another tablet is connected to your computer.

The tablet portion of Cintiq emits electromagnetic waves at a certain frequency. If another tablet is too closely placed to the pen display it may interfere with screen cursor positioning. If this occurs, move the tablet further away from Cintiq.

When working in some applications, the ExpressKeys or Touch Strips perform a different function than what is set in the Wacom Tablet control panel.

Some applications can override and control the ExpressKey and Touch Strip functions. See [using applications integrated for tablet control](#). If using application-specific settings, be sure you have updated the settings for the application you are working with.

The ExpressKeys and Touch Strips do not perform the correct functions to which they are set.

Check to be sure that Cintiq is correctly configured for your preferred handedness. See [configuring Cintiq for handedness and orientation](#).

Some control panel defaults are different from those shown in the manual.

In some regions the control panel defaults may vary, depending on application and operating system differences.





WINDOWS-SPECIFIC PROBLEMS

You suspect the pen display preferences may be corrupted, or want to make certain that all settings are at their factory defaults.

Use the Wacom Tablet Preference File Utility to work with preferences. Close any open applications. Click the START icon and select ALL PROGRAMS. Then select WACOM TABLET and WACOM TABLET PREFERENCE FILE UTILITY.

- It is a good idea to first back up your tablet preferences. In the TABLET PREFERENCE FILE UTILITY dialog box, click BACKUP... and follow the prompts.
- Then use the Tablet Preference File Utility to delete the tablet preferences as follows:
 - Single user. Under MY PREFERENCES, click REMOVE to delete the preferences for the current user.
 - Multiple users. Under ALL USER PREFERENCES, click REMOVE to delete preferences for multiple users. Administrator rights are required to delete preferences for all users. Relaunch any currently open tablet-aware applications that you may be running.

You can quickly restore tablet preferences that have been backed up by clicking RESTORE... under MY PREFERENCES.



MAC-SPECIFIC PROBLEMS

At startup, a dialog box appears telling you that either the driver failed to load or the pen display preferences have not yet been created.

The tablet portion of the pen display was not detected at startup. Make sure the USB cable is securely connected to an active USB port on your computer or USB hub. Make sure that the pen display power LED is on and is glowing blue. If this does not correct the problem, see [troubleshooting](#).

From the GO menu, select UTILITIES and launch the SYSTEM PROFILER. Select USB from the HARDWARE section of the CONTENTS list. A Wacom USB pen display model should be listed. If a pen display model is not listed, check the pen display USB cable connection or try plugging the pen display into a different USB port.

If this does not help, contact Wacom for Technical Support. See [technical support options](#).

You suspect the pen display preferences may be corrupted, or want to make certain that all settings are at their factory defaults.

Use the Wacom Tablet Utility to work with preferences. Close any open applications. Open the main APPLICATIONS folder. Then open the WACOM TABLET folder and run the WACOM TABLET UTILITY.

- It is a good idea to first back up your tablet preferences. In the Wacom Tablet Utility, select CURRENT USER or ALL USERS. Then click BACKUP... and follow the prompts.

- Then, delete the tablet preferences as follows:

Single user. When the utility starts, select CURRENT USER and click REMOVE. Log out, then log back in. When the pen display driver loads it will create a new preferences file with the factory defaults.

Multiple users. When the utility starts, select ALL USERS and click REMOVE. Log out, then log back in. When the pen display driver loads it will create new preferences files with the factory defaults.

You can quickly restore tablet preferences that have been backed up for the CURRENT USER or ALL USERS by clicking RESTORE... within the utility.

Note: Do not manually remove the WACOMTABLET.PREFPANE file from the main LIBRARY PREFERENCEPANES folder. This file is only to be removed when uninstalling the Wacom software driver, and then only when using the Wacom Tablet Utility.

Recalibrate the pen display. See [calibrating the pen display](#).





Ink does not work correctly with the pen display.

There may be a problem with the Ink preferences. Remove the damaged preference files as follows. They will be re-created when you enable handwriting recognition.

1. Open SYSTEM PREFERENCES, choose SHOW ALL and select INK. Then turn off handwriting recognition.
2. From the GO menu, choose your HOME. Open the LIBRARY and PREFERENCES folders. Remove the following preferences:
 - COM.APPLE.INK.FRAMEWORK.PLIST
 - COM.APPLE.INK.INKPAD.PLIST
 - COM.APPLE.INK.INKPAD.SKETCH
3. Go back to SYSTEM PREFERENCES and INK, and then enable handwriting recognition.
4. Test the Ink function using your Wacom pen display and pen.

If this procedure does not resolve your problem with Ink, contact Apple Support for further assistance. Wacom is not the software manufacturer for Ink and we are limited in our abilities to support a third party software application.



TECHNICAL SUPPORT OPTIONS

If you have a problem with your Cintiq interactive pen display, first check the appropriate [installation](#) section in this manual to make sure the pen display is installed correctly. Then review the [troubleshooting](#) procedures.

If you cannot find the answer in this manual, you may find updated information about your problem in the Read Me file for your operating system (located on the Installation CD). You can also check the product FAQs ([Frequently Asked Questions](#)).

If you have an Internet connection, you can download the latest software drivers from the Wacom web site for your region. See [obtaining software updates](#).

Check the Customer Care options on the Wacom web site for your region. You may find answers to your questions without having to make a phone call.

If you cannot solve the problem and you think your Wacom product is not working properly, contact the Wacom support staff for the area where your product was purchased. See the Wacom Read Me file, located on the Installation CD, for contact information. You can also find contact information by checking the Wacom web site for your region.

When you call, you should be at your computer with the following information available:

- This manual.
- Pen display serial number. (See the label on the back of the pen display.)
- Driver version number. (See the Installation CD or click on the Wacom Tablet control panel ABOUT button.)
- The make and model of your computer, and operating system version number.
- The make, model, and connection type of your video card.
- A list of peripheral devices attached to your computer.
- The software application and version you were using when the problem occurred.
- The exact wording of any error message that appeared on your screen.
- What happened and what you were doing when the problem occurred.
- How you tried to solve the problem.

You can also contact the Wacom Customer Care Center by visiting the Wacom web site for your region and completing an Email Inquiry form.

OBTAINING SOFTWARE UPDATES

Wacom periodically updates the tablet software driver to maintain compatibility with new products. If you are having a compatibility problem between Cintiq and a new hardware or software product, it may be helpful to download a new software driver (when available) from the Internet.

Visit the Wacom web site at www.wacom.com for Customer Care and product drivers or other software updates.

FREQUENTLY ASKED QUESTIONS

This section provides answers to some of the more commonly asked questions about Cintiq. To browse more FAQs, visit the Wacom web site for your region.

[Will Cintiq work in all applications?](#)

[What software applications support Cintiq features?](#)

[Can I have Cintiq and a mouse connected to my computer at the same time?](#)

[Can I use older Wacom input tools with Cintiq?](#)

[The installer is asking for a password. What is the password?](#)

[The pen and screen cursor do not line up. Why?](#)

[How do I reset my Cintiq preferences to the default settings?](#)

[Can I delete all Cintiq preferences at one time?](#)

[What is the best way to clean Cintiq?](#)

[How do I change the nib \(tip\) of my pen?](#)

[Where can I obtain spare parts and accessories?](#)

[How do I find the product model and serial number?](#)

Will Cintiq work in all applications?

Cintiq supports general mouse input functions in all applications. Assuming the product driver is installed and functioning properly, pressure sensitivity and eraser functions are also supported in many graphic applications.

What software applications support Cintiq features?

Many applications support pressure sensitivity and eraser input from your Wacom product.

Visit www.wacom.com and search software applications. If you do not find your application listed, try using it with Cintiq to determine if you experience pressure variance when you paint or draw with the pen. Your software manufacturer will be able to provide the best information about which pen input features the application supports.

Can I have Cintiq and a mouse connected to my computer at the same time?

Yes. You can use your system mouse in conjunction with your Wacom product. Only one device at a time can control the screen cursor. You can change back and forth between your Cintiq input tools and a system mouse at your convenience.





Can I use older Wacom input tools with Cintiq?

Pens and accessories are generally specific to the product model they come with, so they may not be interchangeable. Visit the Wacom web site for your region and check the Customer Care Knowledge Base for details.

The installer is asking for a password. What is the password?

The computer is looking for a password that is either your personal password or the administrative password to log into the computer. If your personal password does not work and you are in a business environment you will need to ask the system administrator to install the tablet for you. The operating system requires the user to have administrative access to install a hardware device.

The pen and screen cursor do not line up. Why?

The interactive pen display needs to be calibrated. This should be done each time you reinstall the tablet driver or delete the Cintiq preference file. See [calibrating the pen display](#).

How do I reset my Cintiq preferences to the default settings?

See [managing preferences](#).

Can I delete all Cintiq preferences at one time?

Yes. See [managing preferences](#).

What is the best way to clean Cintiq?

See [caring for Cintiq](#).

How do I change the nib (tip) of my pen?

See [replacing the pen nib](#).

Where can I obtain spare parts and accessories?

See [ordering parts and accessories](#).

How do I find the product model and serial number?

These are labeled on the back of the Cintiq interactive pen display. The model number is typically located above the bar code, and the serial number just below the barcode. The model number and serial number is needed for all Customer Care support requests.



CARE AND MAINTENANCE

This section provides tips for the care and maintenance of your Cintiq 22HD interactive pen display.

[Caring for Cintiq](#)

[Replacing the pen nib](#)

CARING FOR CINTIQ

Keep the Grip Pen and the Cintiq LCD screen surface clean. Dust and dirt particles can stick to the pen and cause excessive wear to the display screen surface. Regular cleaning will help prolong the life of your LCD screen surface and pen.

Keep Cintiq, the Cintiq display stand, and the Grip Pen in a clean, dry place and avoid extremes in temperature. Room temperature is best.

Cintiq, the display stand, and the Grip Pen are not made to come apart. Taking apart the product will void your warranty.

Important: Take care to never spill liquids onto the pen display or pen. Be especially careful of getting the display, ExpressKeys, Touch Strips, or pen buttons and tip wet as they contain sensitive electronic parts that will fail if liquids enter them.

Prevent scratching by replacing your pen nibs frequently. When the nibs are worn or pointed they can damage your pen display. See [replacing the pen nib](#).

To clean the Cintiq casing, the Cintiq display stand, or the Grip Pen, use a soft, damp cloth; you can also dampen the cloth using a very mild soap diluted with water. Do not use paint thinner, benzine, alcohol, or other solvents to clean the product casing or pen.

To clean the display screen, use an anti-static cloth or a slightly damp cloth. When cleaning, apply only a light amount of pressure to the display screen and do not make the surface wet. Do not use detergent to clean the display screen as this may damage the pen display screen. Damage of this kind is not covered by the manufacturer's warranty.

REPLACING THE PEN NIB

To protect your pen display from scratching and for best performance, periodically replace your pen nibs.

Important: Replace the pen nib before or when it looks like this:

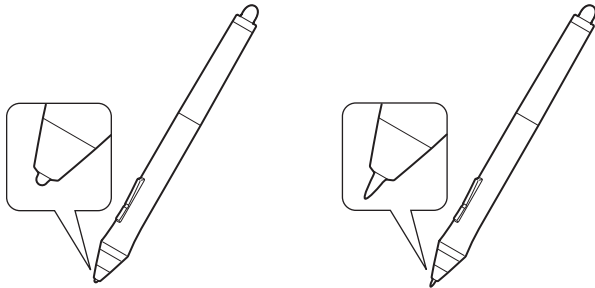

The pen nib (tip) will wear with normal use.

Excessive pressure will cause it to wear more quickly.

Replace the nib when it gets too short or develops a flat point.

1. Unscrew the pen stand base to access the nib removal tool and replacement nibs.

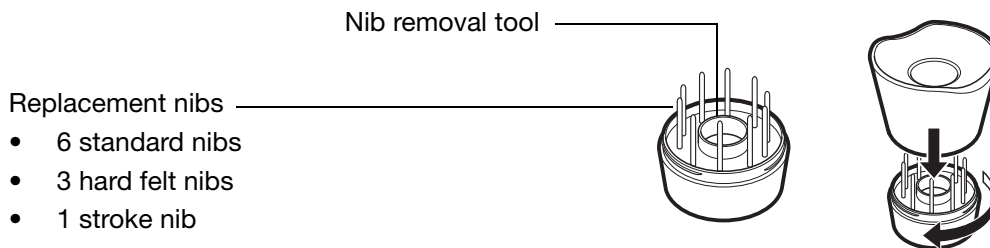

2. Clasp the old nib and pull it straight out of the pen. Use the nib removal tool, pair of tweezers, needle-nosed pliers, or similar instrument.





3. Slide the end of the new nib straight into the barrel of the pen. Firmly push the nib until it stops.

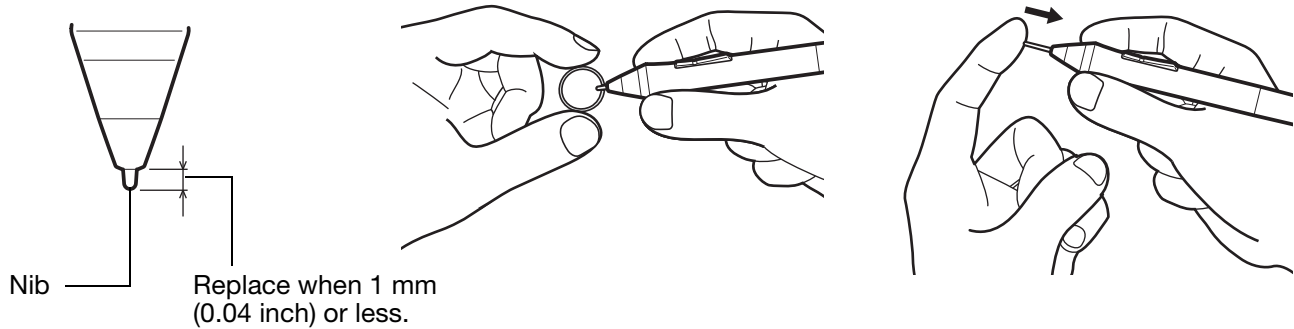

 **Warning**

Choking hazard. Prevent children from swallowing the pen nib or side switch. The pen nib or side switch may accidentally be pulled out if children are biting on them.

For replacement parts, see [ordering parts and accessories](#).

Important:

- When not in use, place the pen in the pen stand or lay it flat on your desk.
- When the optional Airbrush is not in use, lay it flat on your desk.
- To maintain the sensitivity of your input tools, do not store them in a container where they will rest on their tip or eraser. Improper storage may damage the pen tip pressure sensor(s).





OTHER USEFUL INFORMATION

This section includes instructions on how to manage your Cintiq preferences, uninstall the product software, and more.

[Optional display configurations](#)

[Using an alternate mount or stand](#)

[Cable removal and replacement](#)

[Uninstalling Cintiq](#)

[Using the Express View display](#)

[Managing preferences](#)

[Installing multiple tablets](#)

[Using applications integrated for tablet control](#)

[Importing expert settings](#)

[Pen and digital ink capabilities in Windows](#)

[Product information](#)

[Ordering parts and accessories](#)

[Available parts and accessories](#)



OPTIONAL DISPLAY CONFIGURATIONS

After mounting the pen display on the Cintiq stand, you can rotate the pen display to a variety of positions. If you do not plan to rotate the pen display and want to fasten it more securely to the stand, install the rotation lock screws as shown below.

To lock Cintiq to the display stand:

- Rotate the pen display to the standard landscape position (power button will be located at top of the display).
- Two holes in the stand will line up with two screw holes on the pen display.
- Use a Phillips-head screw driver to insert the lock screws and hand-tighten them.

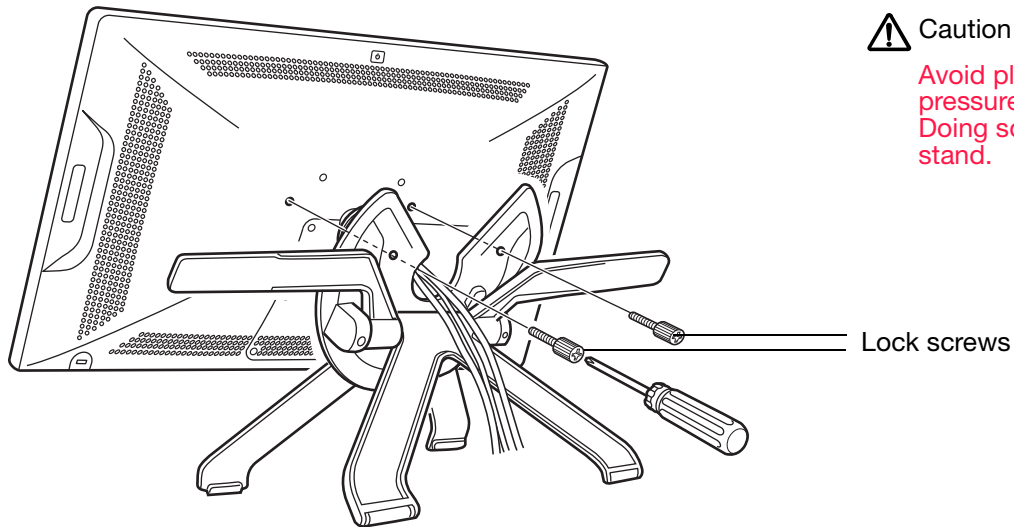

Caution

Avoid placing excess physical pressure on the Cintiq stand. Doing so can damage the stand.

USING AN ALTERNATE MOUNT OR STAND

If using Cintiq in an installation that requires the use of an alternate mounting platform, you can mount the pen display onto any stand or mounting platform conforming to the VESA MIS-D 100/100 (4 screw) standard.

Notes:

Required mounting screws are 4 mm wide with a 0.7 mm pitch (M4 Regular). The pen display screw holes depth is 12 mm. Exceeding the clearance depth will damage the internal components of the pen display.

Any platform or fixture on which Cintiq is mounted must be able to support the weight of the interactive pen display.

To attach the pen display to a VESA mount:

1. Turn off your computer and power off Cintiq. Then disconnect all cables from between the pen display and your computer.
2. [Remove Cintiq from the display stand](#). Place the pen display face down on a flat, soft surface (such as a cloth spread across a desktop).
3. Remove the bearing hub by unscrewing the four bearing hub attachment screws. Carefully separate the bearing halves and remove the bearing stopper to free up the cabling. Take care not to lose the small bearing stopper found within the inner groove of one of the hub sections.

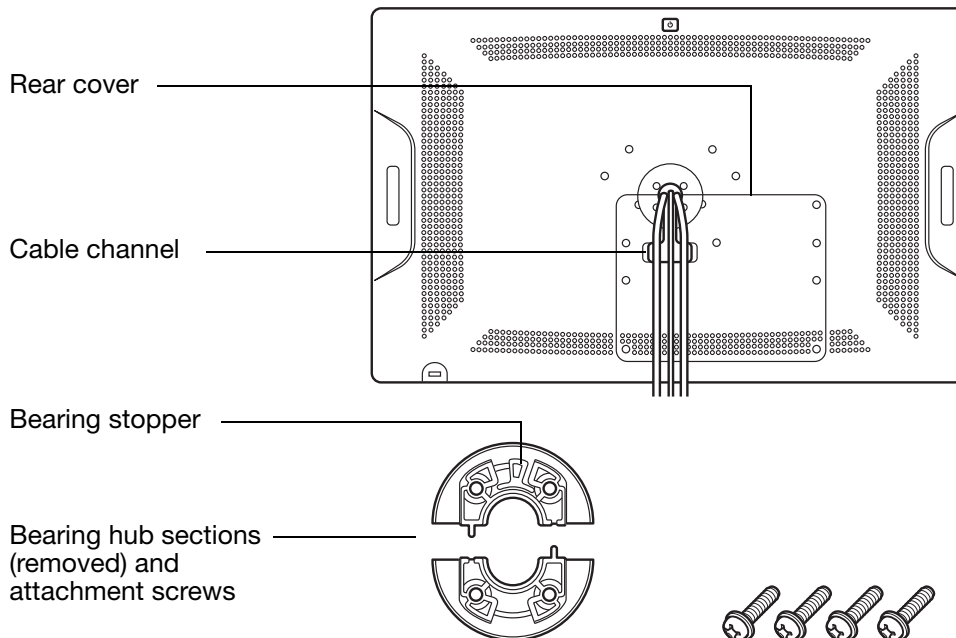

- Remove screws from rear cover and lift cover away from the pen display.
- Thread cables through the cable channel and reattach the rear cover, making sure to use the correct screws. The rear cover screws are shorter than the bearing hub screws.



- Review the instructions that came with your stand or mounting platform. Be sure you understand them, and follow all instructions carefully. Pay attention to any cautions or other safety information.
- Using the appropriate VESA mounting screws for your platform and as indicated above, firmly attach the pen display to the mounting platform.

Warning

When attaching the pen display onto an alternate mounting platform, be sure to follow all instructions in the documentation supplied by the platform manufacturer. If improperly installed, the pen display could fall, resulting in physical injury or damage to the product.

Cable channel

Cables should be threaded through this opening without crimping.

Ensure the cables are not pinched beneath the VESA attachment.

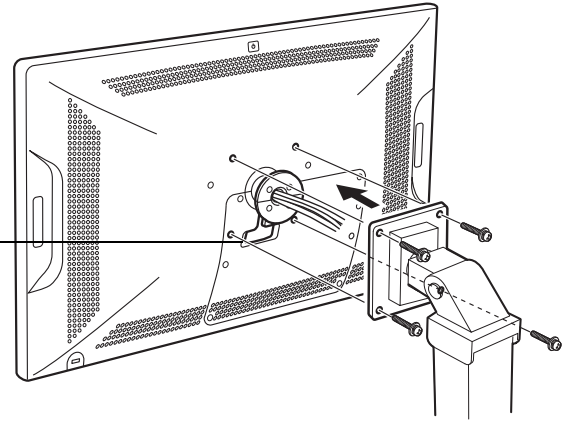

- Reattach the cabling between the pen display and your computer. As necessary, refer to [step 1: hardware installation](#).

To remove the pen display from a VESA mount:

- Turn off your computer and power off Cintiq. Then disconnect all cables from between Cintiq and your computer.
- Remove Cintiq from the alternate mounting platform.
- Place the pen display face down on a flat, soft surface (such as a cloth spread across a desktop).
- Remove the rear cover and unthread the cables from the cable channel. After freeing up the cables, replace the cover.

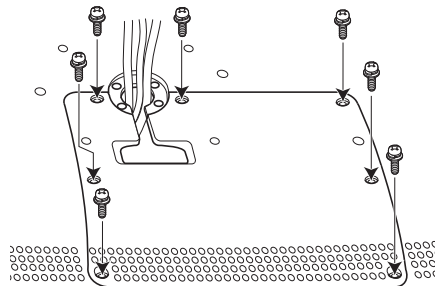

5. Study the bearing hub components. You should have two bearing hub sections, a bearing stopper, and four screws. Locate the bearing stopper within one of the bearing hub sections. Either hub section can be used as they are identical parts.

Illustrates correct location of bearing stopper within bearing hub section.

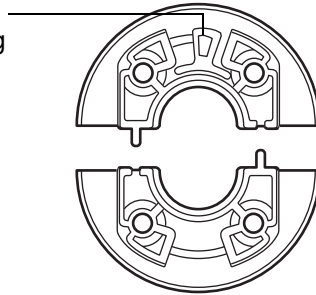

When correctly placed, the bearing stopper will shift smoothly from side to side within the stopper groove. The stopper will also sit flush with the rear hub surface.

6. Taking care not to dislodge the bearing stopper from the hub section, position the two halves of the bearing hub together around the pen display cables and over their attachment points.

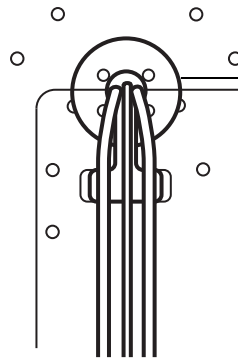

Proper positioning shows the hub sections aligned along the horizontal axis of the pen display.

The section containing the bearing stopper should be positioned toward the top of the pen display.

7. Attach the bearing hub sections to the pen display, making sure to use the correct screws for reattachment. (The bearing hub screws are longer than the rear cover screws.)

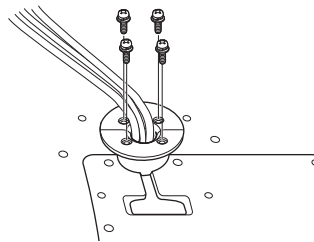

CABLE REMOVAL AND REPLACEMENT

If you should need to remove or replace a Cintiq cable, follow the below procedure.

Remove a cable:

1. Turn off your computer and power off Cintiq. Disconnect all cables from between the pen display and your computer.
2. [Remove Cintiq from the display stand](#). Place the pen display face down on a flat, soft surface (such as a cloth spread across a desktop).
3. Remove the bearing hub by unscrewing the four bearing hub attachment screws. Carefully separate the bearing halves and remove the bearing stopper to free up the cabling. For details, refer to the instructions found in [using an alternate mount or stand](#).
4. Loosen the rear cover screws and lift the cover away from the pen display.

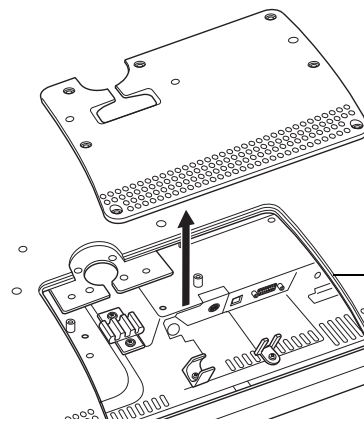
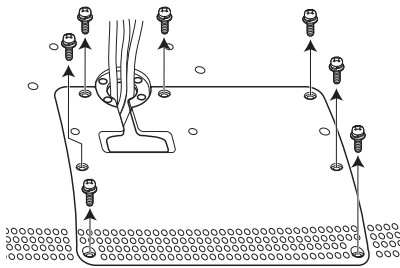

Connectors are DVI-I, USB, and power.

5. Remove the cable clip and unseat the cable.

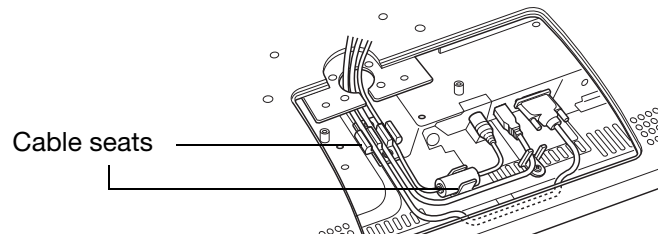
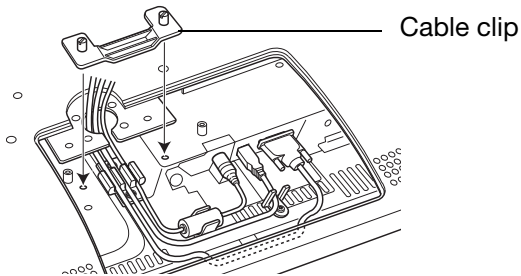

6. If the cable you wish to remove has thumbscrews, loosen them. Disconnect and remove the cable.



Replace a cable:

1. Connect the cable to the pen display. Make sure to tighten any connector thumbscrews.
2. Properly seat the cable and install the cable clip.
3. Carefully replace the rear cover, making sure not to crimp any cables beneath it. Use the correct screws when replacing the cover, and do not overtighten them.
4. Carefully reinstall the bearing hub. For details, refer to the instructions found in [using an alternate mount or stand](#).

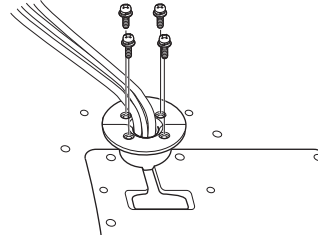
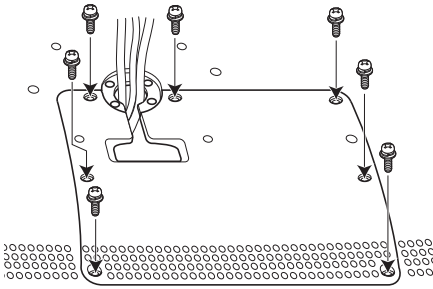

5. [Mount Cintiq on the display stand.](#)
6. Reconnect the cabling between Cintiq and your computer.

UNINSTALLING CINTIQ

Follow the appropriate procedure below to remove the Wacom driver software and the Cintiq interactive pen display from your system.

Important: When you remove the Wacom driver software, your interactive pen display will no longer operate with full tablet functionality but will continue to function as a mouse device.

Windows:

1. Click on the Windows START button and open the CONTROL PANEL.
2. In the CONTROL PANEL window for
 - Windows 7 and Vista: click on UNINSTALL A PROGRAM. In the dialog box that appears, choose WACOM TABLET and click UNINSTALL.
 - Windows XP: select ADD OR REMOVE PROGRAMS. In the ADD OR REMOVE PROGRAMS window, choose WACOM TABLET and click REMOVE.
3. Follow the prompts to remove the software driver. If prompted, enter your administrator log on name and password.
4. When the driver has been removed, shut down your system, power off your computer, and turn off the pen display. When your computer and pen display are off, disconnect the pen display from your computer.

Mac:

1. From the GO menu, choose APPLICATIONS and open the WACOM TABLET folder.
2. Double-click on the WACOM TABLET UTILITY icon. Click on the TABLET SOFTWARE: REMOVE button. Enter your administrator log on name and password.
3. After the removal is completed, click OK.
4. Shut down your computer and turn off the pen display. When your computer and pen display are off, disconnect the pen display from your computer.

See [obtaining software updates](#) for information on downloading a new software driver (when available) from the Internet.

USING THE EXPRESS VIEW DISPLAY

Press a Touch Strip Mode button for 2 seconds or more to activate the Express View display on your primary monitor. The display shows the current ExpressKey setting(s).

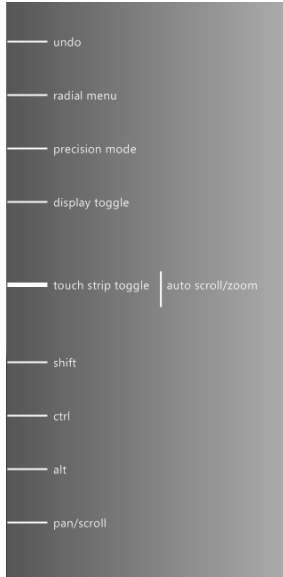

Press and hold the left Touch Strip Mode button to view settings for the left side ExpressKeys.

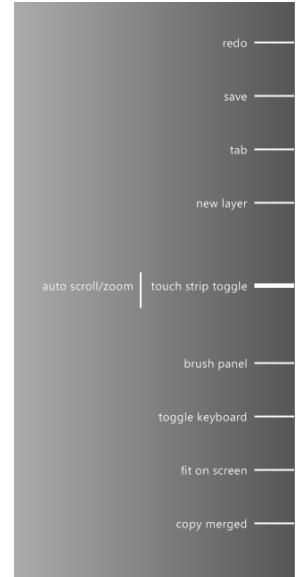
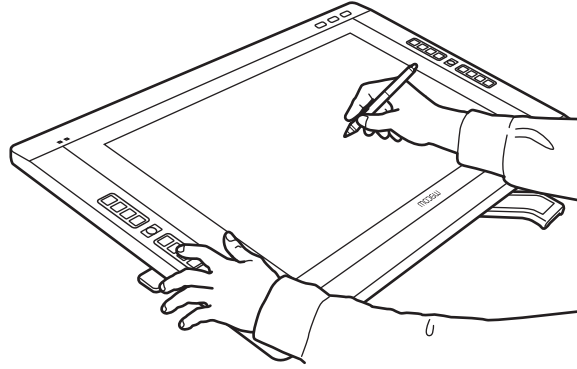

Press and hold the right Touch Strip Mode button to view settings for the right side ExpressKeys.

The Express View display closes approximately 1 second after you release the Touch Strip Mode button.

MANAGING PREFERENCES

Use the Wacom tablet preferences utility to manage your pen display preferences for single or multiple users.

Windows: First close any open applications. Then open the utility by clicking the START icon and selecting ALL PROGRAMS. Select WACOM TABLET and WACOM TABLET PREFERENCE FILE UTILITY.

- To remove preferences for the current user, click REMOVE under MY PREFERENCES.
- To delete preferences for multiple users, click REMOVE under ALL USER PREFERENCES. Administrator rights are required to delete preferences for all users. Relaunch any currently open tablet-aware applications that you may be running.
- To back up your preferences, click BACKUP... under MY PREFERENCES.
- To restore preferences that you had previously backed up, click RESTORE... under MY PREFERENCES.
- Carefully follow any prompts that may appear.

Mac: Open the main APPLICATIONS folder. Then open the WACOM TABLET folder and run the WACOM TABLET UTILITY.

- To remove preferences, select CURRENT USER or ALL USERS. Then click REMOVE. Log out, then log back in. When the software driver loads it will create a new preferences file with the factory defaults.
- To back up your preferences, select CURRENT USER or ALL USERS. Then click BACKUP....
- To restore preferences that you had previously backed up, select CURRENT USER or ALL USERS. Then click RESTORE....
- Carefully follow any prompts that may appear.

INSTALLING MULTIPLE TABLETS

Any pen display or tablet that has been detected on your system will appear as an icon within the Wacom Tablet control panel TABLET list.

Select a pen display or tablet icon for which to customize tool and application settings.

- The control panel will not launch unless a supported pen display or tablet is connected to the computer.
- Settings can only be viewed or changed for an attached pen display or tablet.

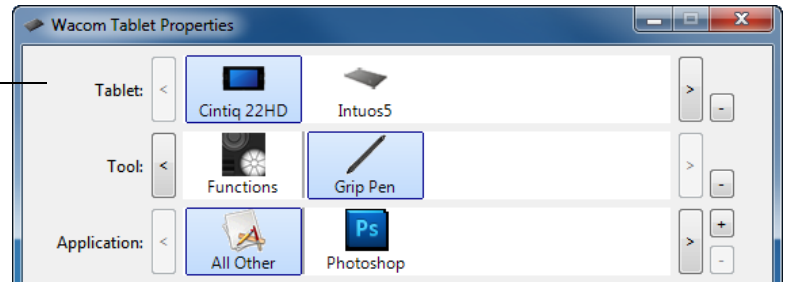

To add a new pen display or tablet, connect it to your computer. The system will automatically find the pen display or tablet and initialize it. An icon for the pen display or tablet will then appear in the control panel.

Important: When installing additional pen display units or tablets on Windows systems, the eraser function may not work in some applications when using the additional pen display(s) or tablet(s). The eraser function will continue to work correctly using the first pen display or tablet that was added to the control panel.

To remove one of multiple pen displays or tablets from the driver, select the pen display or tablet to be deleted and click on the [-] button next to the TABLET list.

- A pen display or tablet must be attached to the computer before it can be deleted from the control panel list.
- You will need to restart your computer before you can again add the tablet to the driver.



USING APPLICATIONS INTEGRATED FOR TABLET CONTROL

Some software applications may be designed to directly control ExpressKey or Touch Strip functions. When working in an application that has been integrated in this manner, the ExpressKeys or Touch Strips may perform differently than the function that is set in the Wacom Tablet control panel.

- When an ExpressKey is overridden by an application, the ExpressKey setting will automatically update, using either “Application Defined” or the new function name. Some or all of the ExpressKeys may be overridden, depending on the application.
- When an application overrides a Touch Strip, all Touch Strip functions are affected. If an application overrides only some of the available Touch Strip functions, the remaining function(s) are set to SKIP.
- An integrated application will control the ExpressKeys or Touch Strips only when that application is active and in the foreground. When you close the application or select a new application pane to work in, your Wacom Tablet control panel settings are returned to their previous state.
- To review ExpressKey, Touch Strip, or pen function settings for the current front-most application, set an ExpressKey to SETTINGS and press the key at any time.

Applications that have been integrated in this manner will typically provide you with the opportunity to opt-out or disable this functionality when first using your Wacom product with the application. See the documentation provided with your application for any specific details on functionality and how to customize or disable this feature.

If an automatic prompt or the application’s documentation do not describe how to disable this behavior, you can use the Wacom Tablet control panel to create [application-specific settings](#) that will override the behavior of the integrated application. See also [managing preferences](#).

Important: If an application-specific setting has been created for an integrated application, setting an ExpressKey or Touch Strip function to APPLICATION DEFINED will still allow the integrated application to control the function.



IMPORTING EXPERT SETTINGS

The import expert settings feature enables you to import customized Wacom Tablet control panel settings that have been specified in an XML (Extensible Markup Language) file.

- Some software developers may create custom settings files which are specifically designed to provide optimum performance when using your Wacom product with their applications.
- Visit the Wacom web site for your region to choose from a variety of custom settings files that may be available for your product.
- Each XML file may include customized settings for one or more applications. These settings may apply to the ExpressKeys, Touch Strips, Radial Menu, or pen button and eraser functions.

To import expert settings:

1. Choose an XML file with settings for use with a particular application. Double-click on your file selection.
2. Carefully read and follow the instructions in the confirmation dialog.
 - The utility will import settings for one or more applications. Any previous settings for those applications may be overridden.
 - You are encouraged to back up any existing control panel settings before importing the expert settings.
 - You can cancel, or continue to import the settings.
3. When you choose to import settings, only the settings specified in the XML file will be imported. Any corresponding settings will be overridden with the new values. All other existing settings will remain unchanged.
4. After the import process is completed you will have an opportunity to view the new settings within the Wacom Tablet control panel.

PEN AND DIGITAL INK CAPABILITIES IN WINDOWS

Microsoft Windows 7 and Vista provide extensive support for pen input. Pen features are supported in all versions of Windows 7 and Vista except Windows 7 Starter and Home Basic, and Windows Vista Home Basic. Use Cintiq and your Wacom pen for quick, intuitive results.

- **Note taking.** Jot notes and capture quick sketches in Windows Journal. Use the Journal search engine to locate your handwritten content.
- **Handwriting recognition.** Quickly enter handwritten information anywhere the computer accepts typed input. Convert your handwritten content to typed text at any time.
- **Gestures.** Make simple gestural movements on the pen display to trigger customizable actions. To customize gestures, select the FLICKS tab in the Windows 7 PEN AND TOUCH or Windows Vista PEN AND INPUT DEVICES control panel.
- **Digital Ink in Microsoft Office 2007.** Utilize the enhanced digital mark-up and inking tools found on the REVIEW tab within applicable applications.

The Windows 7 or Vista Input Panel enables you to use handwriting or an on-screen keyboard to directly enter text with your Wacom pen.

There are different ways to launch the Input Panel:

- Click on the Input Panel icon which appears when you move the screen cursor into a text entry area.
- Click on the Input Panel tab, located by default on the left edge of the display screen.
- Click on the Tablet PC Input Panel icon located on the Windows Taskbar. If the icon is not visible, right-click on the Taskbar, select TOOLBARS, and TABLET PC INPUT PANEL.

To disable the Input Panel:

1. Open the Tablet PC Input Panel.
2. Select TOOLS and OPTIONS.
3. Choose the OPENING tab and uncheck the following boxes:
 - FOR TABLET PEN INPUT, SHOW THE ICON NEXT TO THE TEXT BOX
 - SHOW THE INPUT PANEL TAB.
4. Click OK.

For details, study the documentation that came with your system, including the Windows training tools and Tablet PC tutorial. To access the Tablet PC Pen Training, from the START menu choose ALL PROGRAMS, TABLET PC, and TABLET PC PEN TRAINING. Search the Windows help system for training tools if they are not available from the START menu.





Search the Microsoft web site for enhanced information about digital inking in Windows. You can also visit the Wacom web site at www.wacom.com and search digital inking in Windows.

Note: The following workarounds in the Wacom software driver improve performance in Windows 7 and Vista:

- The Pen Flicks and 'press-and-hold-to-right-click' features are disabled in graphics applications using the Wintab API.
- There is no pressure sensitivity in Journal and other Ink features when both the Flicks and 'press-and-hold-to-right-click' features are disabled in the Windows 7 PEN AND TOUCH or Windows Vista PEN AND INPUT DEVICES control panel.

PRODUCT INFORMATION

To learn more about your Cintiq, visit the Wacom web site for your region. You can also discover which software applications are currently tablet enhanced to support the pressure sensitivity and other special functionality of your pen display by searching software applications.

USA, Canada, Central and South America	http://www.wacom.com
Europe, Middle East and Africa	http://www.wacom.eu
Japan	http://wacom.jp
Asia Pacific (English)	http://www.wacom.asia
China (Simplified Chinese)	http://www.wacom.com.cn
Hong Kong (Traditional Chinese)	http://www.wacom.com.hk
Korea	http://www.wacom.asia/kr
Taiwan	http://www.wacom.asia/tw
Thailand	http://www.wacom.asia/th



ORDERING PARTS AND ACCESSORIES

To purchase [available parts and accessories](#), refer to the Wacom pen display Read Me file and see who to call for your region.

You can also do the following:

- In the USA or Canada, call 1.888.884.1870 (toll-free) or visit Wacom's web site at <http://direct.wacom.com> (USA only).
- In Europe, call +49 (0)180.500.03.75 or send an email to spareparts@wacom.eu. Or, visit <http://shop.wacom.eu>. You can also contact your local dealer, distributor, or technical support using the appropriate number for your region.
- In Australia, Singapore, Taiwan and Korea, please visit: www.BuyWacom.com.au, www.BuyWacom.com.sg, www.BuyWacom.com.tw and www.BuyWacom.co.kr, respectively.
- In other countries, please contact your local dealer or distributor.

Some parts and accessories may not be available in all regions.

AVAILABLE PARTS AND ACCESSORIES

For a list of available parts and accessories, visit the Wacom web site for your region. See [ordering parts and accessories](#).

GLOSSARY

Active area. The area of the pen display where your Cintiq tools are detected.

Application-specific settings. Cintiq tool and pen display settings that have been customized for individual applications. The Wacom Tablet control panel enables you to customize a tool to behave uniquely in different applications. [Application-specific settings](#) are in effect whenever you use the application.

Aspect. The ratio between the vertical and horizontal dimension of the active area on the pen display.

Click force. The amount of force you must apply to the pen tip for a click to occur.

Double-click assist. A function of the Wacom Tablet control panel that makes it easier to double-click by setting the size of the double-click distance.

Double-click distance. The maximum distance (in screen pixels) that the screen cursor can move between clicks and still be accepted as a double-click. Increasing the double-click distance makes double-clicking easier, but may cause a delay in brush strokes in some graphics applications.

Eraser-aware application. A software application that has built-in support for the pen eraser. These applications take advantage of the eraser in different ways, depending on what makes sense for the application.

ExpressKeys. The customizable control keys located on the pen display. See [using the ExpressKeys](#).

Fingerwheel. The control wheel on the optional Airbrush.

Hardware control buttons. The function buttons located on the pen display. See [using the hardware control buttons](#).

Journal. A Microsoft Windows application that electronically simulates a physical journal pad, but with the advantages of digital note taking. For example, you can create quick sketches and jot handwritten notes that can be converted to text and sent on to colleagues for digital mark-up. Journal includes a variety of pen, marker, and highlighter tools, plus an eraser that is easily activated by the eraser end of your Wacom pen. Additionally, your handwritten content is searchable within Journal.

LED. Light-Emitting Diode. Used as pen display indication light(s).

Modifier. Modifier keys include SHIFT, ALT, and CTRL for Windows, or SHIFT, CONTROL, COMMAND, and OPTION for Mac. You can customize your Cintiq tool buttons or ExpressKeys to simulate a modifier key.

Mouse acceleration. A setting that allows you to adjust the screen cursor acceleration when using mouse mode.

Mouse mode. A method for positioning the screen cursor. When you place a Cintiq tool on the tablet, you can move the screen cursor with a “pick up and slide” motion similar to using a traditional mouse. This is known as relative positioning. See also [pen mode](#).



Mouse speed. A setting that allows you to adjust the speed at which your screen cursor moves when using mouse mode.

Nib. The replaceable pen tip.

Parallax. The angular distortion of an object's position when viewed through glass or other medium. You must calibrate the pen display to compensate for this effect, and to align the screen cursor with the position of the pen on the display screen.

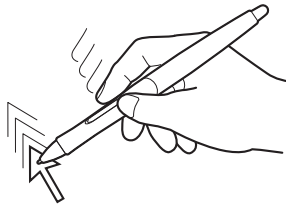

No parallax. The pen tip and screen cursor are aligned.

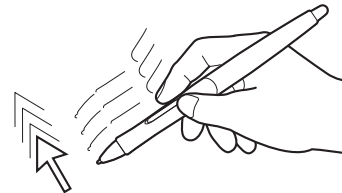

Parallax effect caused by display screen glass. Note how the position of the pen tip and screen cursor are not aligned.

Pen mode. A method of positioning the screen cursor. Wherever you place your Cintiq tool on the pen display tablet, the screen cursor will jump to the corresponding point on the screen. This is known as absolute positioning, and is the default setting for the pen. Pen mode allows you to quickly position the screen cursor without having to first find it and then move it across the desktop. See also [mouse mode](#).

Pixel. The smallest unit of measure on your display screen.

Pressure sensitive. A quality of the Wacom pen tip and eraser that senses the amount of pressure being applied. This is used to create natural-looking pen, brush, and eraser strokes in applications that are pressure sensitive.

Pressure-sensitive application. Any application that supports pressure-sensitive input.

Proximity. The height above the pen display [active area](#) where the Cintiq input tools are detected. See also [pen features](#).

Radial Menu. A hierarchical menu (in radial format). Each level of the menu consists of eight menu slices which may contain various features and options to choose from. You can customize the buttons of your input tools or Cintiq to display this menu.

Screen cursor. The pointer on the display screen. Screen cursors come in different shapes (such as an I-beam, arrow, or box), depending on which application you are running.

Tablet PC Input Panel (TIP). The Microsoft Windows Tablet PC Input Panel enables you to use your Wacom pen to create handwritten notes or work with an on-screen keyboard. The Input Panel dynamically converts your handwriting to text. The information you create can then be inserted into other documents, spreadsheets, or illustrations.



Tilt sensitive. A quality of the pen tip and eraser that senses the amount of tilt between the tool and tablet. This is used to create natural-looking pen, brush, and eraser strokes in applications that are tilt sensitive.

Touch Strips. The customizable control strips located on the back of the pen display. See [using the Touch Strips](#).

USB. Universal Serial Bus. A hardware interface standard for connecting computer peripheral devices. USB ports support hot-plugging, which allows you to connect or disconnect a USB device without turning off your computer.

Wintab. An interface standard used by Windows applications for receiving tablet information. Cintiq supports all Wintab-compatible applications under Windows.



INDEX

About the manual	5	Clicking, with pen	26
Accessories		Control panel	
available	104	lists	43
ordering	104	manage settings	41
Adding a new tool	64	opening	41
Adjusting, pen display	36	overview	42
Applications, integrated for tablet control	100	tabs	43
Application-specific settings		Controls, testing	69
changing settings	63	Customizing	40
creating	62	eraser feel	47
removing	63	ExpressKeys	50
working with	61	pen	45
Auto-sync	36	pen display functions	49
Box		Radial Menu	59
contents	6	tilt sensitivity	49
unpacking	6	tool buttons	48
Button functions	52	Touch Strips	51
Cables, removal and replacement	94	Digital ink, capabilities in Windows	102
Calibrating, pen display	44	Display	
Care and maintenance	86	problems, general	72
Cintiq		troubleshooting	72
about	18	Display stand	7
caring for	86	adjusting incline	11
customizing	40	features	8
display stand	7	location	9
installation	13	mounting the pen display	10
overview	18	removing pen display from	12
setting up	13	Display Toggle, working with	60
testing	67	Double-click, adjusting	46
troubleshooting	66	Dragging, with pen	27
uninstalling	96	Eraser feel, customizing	47
working with	22	Eraser pressure setting, advanced	47
Cleaning		Ergonomics	22
display stand	86	Expert settings, importing	101
pen	86	Express View display	97
pen display	86		





ExpressKeys	29	erasing, with	28
testing	70	features	21
using	31	holding	25
Factory presets	36	nib, replacing	87
FAQs (Frequently Asked Questions)	84	positioning with	26
Features		pressure sensitivity, working with	27
display stand	8	testing	71
pen	21	tilt, drawing with	28
pen display	18	using	24
Front view, pen display	19	using side switch	27
Functions, button	52	Pen display	
General problems, troubleshooting	75	adjusting	36
Handedness, configuring for	24	adjusting rotation	11
Hardware control buttons		calibrating	44
testing	70	configuring handedness	24
using	30	controls	29
Hardware installation, for pen display	14	customizing functions	49
Incline, adjusting	11	features	18
Information, product	103	front view	19
Input tools, testing	69	incline, adjusting	11
Installation	13	installation	13
hardware	14	hardware	14
software	17	software	17
Mac-specific problems, troubleshooting	80	mounting on stand	10
Maintenance and care	86	optional configurations	90
Manual, about	5	rear view	20
Monitors, using Cintiq with others	35	setting up	13
Mount, using alternate	91	Touch Strips, customizing	51
Multiple tablets, installing	99	Pen nib, replacing	87
Multiple tools, working with	64	Pen tablet, troubleshooting	75
New tool, adding	64	Pens, optional	45
On Screen Display (OSD)	37	Positioning, with pen	26
Ordering, parts and accessories	104	Power saving, functions	39
Parts		Preferences, managing	98
available	104	Pressure sensitivity, working with	27
ordering	104	Product information	103
Pen		Radial Menu	
clicking with	26	customizing	59
customizing	45	using	59
dragging with	27	Rear view, pen display	20





Requirements, system	13	Tip feel, adjusting	46
Rotation, adjusting	11	Tip pressure setting, advanced	47
Setting up	13	Tool buttons, customizing	48
Settings		Touch Strips	29
changing for specific application and tool	63	customizing	51
On Screen Display (OSD)	37	testing	70
removing	63	using	33
user	36	Troubleshooting	66
Side switch, using	27	display portion	72
Software		general problems	75
installation	17	Mac-specific problems	80
updates	83	pen tablet portion	75
Stand, using alternate	91	testing controls	69
System requirements	13	testing input tools	69
Tablet, renaming in Tablet list	65	Windows-specific problems	79
Technical support, options	82	Uninstalling	96
Testing		Unpacking	6
Cintiq	67	box contents	6
controls	69	User settings	36
ExpressKeys	70	Using	
hardware control buttons	70	ExpressKeys	31
input tools	69	hardware control buttons	30
pen	71	pen	24
Touch Strips	70	Touch Strips	33
Tilt		VGA problems	74
drawing with	28	Windows-specific problems, troubleshooting	79
sensitivity, customizing	49	Work area, setting up	22
		Working, with Cintiq	22





WACOM INTERNATIONAL OFFICES

WACOM TECHNOLOGY CORPORATION

1311 SE Cardinal Court
Vancouver, WA 98683
U.S.A.

Telephone: +1.360.896.9833

Fax: +1.360.896.9724

WACOM CO., LTD. JAPAN TABLET SALES DIVISION

Harmony Tower 18F, 1-32-2 Hon-Cho,
Nakano-Ku, Tokyo 164-0012
Japan

Internet: <http://wacom.jp>

WACOM CHINA CORPORATION

1103, Beijing IFC West Tower
No. 8 Jianguomenwai Street
Chaoyang District, Beijing, 100022
China

Internet: <http://www.wacom.com.cn>

WACOM AUSTRALIA PTY. LTD.

Unit 8, Stage 1 Cumberland Green
2-8 South Street Rydalmere
NSW 2116 Australia

Telephone: +61.2.9422.6700

Fax: +61.2.9420.2272

WACOM TAIWAN INFORMATION CO., LTD.

Suite 605, 6th floor, No. 205 Tun-Hwa North Road
Taipei, 105 Taiwan

Telephone: +886.2.2712.2675

Fax: +886.2.2712.9789

WACOM EUROPE GMBH

Europark Fichtenhain A9
47807 Krefeld
Germany

Internet: <http://www.wacom.eu>

WACOM CO., LTD. ASIA PACIFIC DIVISION

Harmony Tower 18F, 1-32-2 Hon Cho,
Nakano-Ku, Tokyo 164-0012
Japan

Telephone: +81.3.5309.1513

Fax: +81.3.5309.1514

WACOM KOREA CO., LTD.

#1211, 12F, KGIT Sangam Center,
1601 Sangam-dong, Mapo-gu, Seoul 121-913, Korea

Telephone: +82.2.557.3894

Fax: +82.2.557.3895

WACOM SINGAPORE PTE. LTD.

5 Temasek Boulevard
#12-09 Suntec Tower Five
Singapore 038985

Telephone: +65.6258.8640

Fax: +65.6258.8697

WACOM HONG KONG LIMITED

Room 1201, Tai Tung Building
8 Fleming Road
Wanchai, Hong Kong

Telephone: +852.25739322

Fax: +852.25739500

